



O-Ring Guide

Catalog ORD 5712UK



For the latest information on Parker O-Ring Division products,
visit www.parker.com/euro_oring

Compatibility of Seals and Operating Media / Cleansing Agents

Due to the great diversity of operational parameters affecting fluidic devices and their impact on seals, it is absolutely imperative that manufactures of these devices release seals for functional and operational suitability under field conditions.

Furthermore, in view of the consistent increase of newly available media used as hydraulic oils, lubricants, and cleansing agents, special attention is invited to the aspect of compatibility with sealing elastomer currently in use.

Additives contained in base media in order to enhance certain functional characteristics may affect compatibility characteristic of sealing materials.

For this reason, it is imperative that any product equipped with our seals be tested for compatibility with operational media or cleansing agents approved or specified by you either at your plant or by means of field tests prior to any serial application.

We kindly ask you to comply with this notice since, as a manufacturer of seals, we are not in a position, as a matter of principle, to perform simulations regarding any and all conditions present in the final application nor of knowing the composition of the operational media and cleansing agents used.

Please regard this information as a manifestation of our continual endeavour to provide optimum delivery and consulting services to our customers.

All information in this catalogue is based upon years of experience in the manufacture and application of sealing elements. In spite of all efforts on our part, suggestions included here cannot be regarded as generally binding because of the various unknown factors which arise in particular applications

O-Ring Guide

Table of Contents

Introduction	2
O-Ring Material Offering	7
Engineering Tools	29
Gland Designs	37
Sizing Charts	47

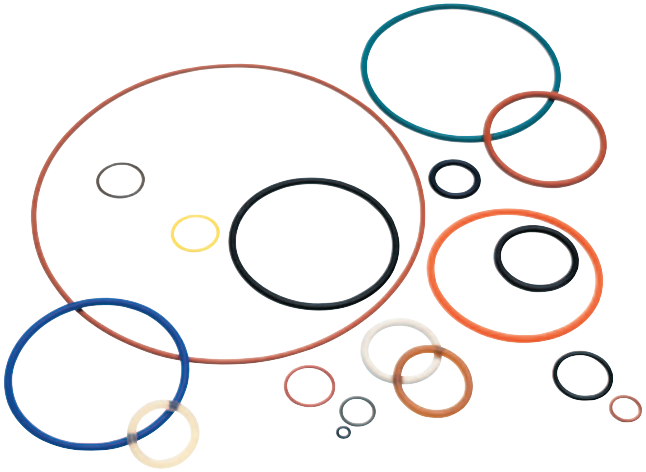



Manufacture near to the customer

The Parker Hannifin Corporation Seal Group is a worldwide leader in the development, manufacture and sales of seals, vibration control, systems for shielding against electromagnetic interference as well as thermal

management materials. The Group manufactures in more than 43 facilities, eight of which are in Europe.

Certification in accordance with DIN EN ISO 9001 and ISO/TS16949 ensures that the manufacturing sites are reliable partners for the automobile and other areas of industry with exacting quality requirements.

Research and Development

Parker Seals work together with customers from nearly all branches of industry to ensure that up to date information is already available in the product development stage.

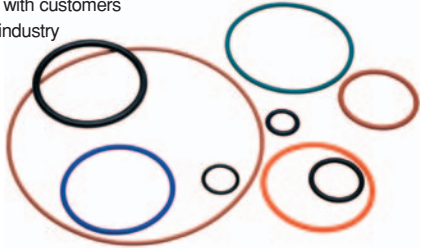

Computer simulation

Finite Element Analysis (FEA) can be used for prediction of the service life of elastomer components. The functions of the material properties are determined in relationship to time, temperature and load.

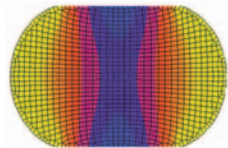

Complex mathematical models also serve for the geometrical configuration and calculation of the performance of sealing systems.

Literature

Since their initial release decades ago, the O-Ring Handbook 5705DE-UK (published in Europe in various languages) have become fixtures on the reference shelves of engineers and seal specifiers worldwide.



These books contain extensive information about the properties of basic sealing elastomers, as well as examples of typical o-ring applications, fundamentals of static and dynamic seal design and o-ring failure modes.

They also provide an overview of international sizes and standards, and contain compatibility data for fluids, gases and solids. Abridged versions of these books, available as ORD 5712 UK and 5705 DE-UK, provide engineers with fast access to information on standard sizes and materials.

PC software for users

With the "inPHorm" computer programs it is easy to find the seal most suitable for a specific application. The PC software comprehensively and transparently shows the way for calculation and selection of the technically correct product.

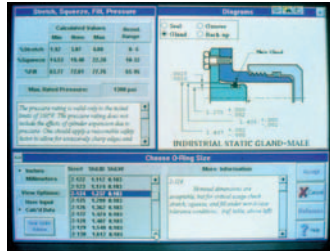

Compounds

Parker develops and produces rubber mixtures and polymerizes the most thermoplastics in its own facilities.

Temperature ranges extend from -60°C (Silicone) to +320°C (Perfluoro Rubber). PTFE and Perfluoro Rubber are resistant to nearly all chemicals, whilst Polyurethane is especially suitable for exacting requirements regarding ultimate tensile strength as well as resistance to extrusion and attrition.

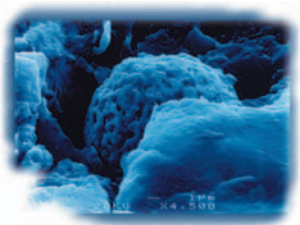

Product lines

Parker manufactures O-rings and special moulded parts for use in automobile manufacture, chemical and biochemical engineering, fluid engineering, refrigeration and air conditioning, mineral oil, aerospace and semiconductor industries as well as many other branches of industry.

Facilities in Germany, Italy, the Czech Republic, USA, Brazil, Argentina, Mexico and China

Products:

- Precision O-rings
- Col-O-Ring® programme
- Parbak® back-up rings
- Hifluor seals in highly fluorized Fluoro carbon rubber (FKM)
- Parofluor® seals in Perfluoro Rubber
- Silicone seals and diaphragms
- TSD precision extruded components
- O-ring kits
- Assembly greases and lubricants
- Precision moulded parts



O-ring Kits

The great O-ring hunt draws to an end – with an O-ring Kit from Parker.

Ideal for repair, fitting and assembly workshops. Available in various versions: selected repair Kits, consisting of a wide range of standard, metric or imperial sizes in proven Parker compounds. The optimum usage of O-rings is assured because the Kit is clearly arranged and always ready for use – the proven equipment for a fast operation.



Detailed information to O-ring compounds for Kit 1 and 2.

Elastomer	Parker compound	Hardness Colour	General application recommendation (for more information see Parker Fluid compatibility table 5703 E)
Nitrile Butadiene Rubber NBR	N 674-70	70 Shore A black	Generally recommended for Hydraulics, Pneumatics and water/Glycol. Compatible with mineral, animal and vegetable oil, water up to 70°C, air up to 100°C.
	N 552-90	90 Shore A, black	Compatibility as N 674-70. High resistance to extrusion.
Ethylene Propylene EPDM	E 540-80	80 Shore A black	Steam, hot water, compressed air, dilute-acids, phosphate ester fire-resistant fluids, Hydraulic fluids, brake fluid on non-mineral oil base.
Fluorocarbon FKM	V 747-75	75 Shore A black	For high temperatures, hot oil, aromatic solvents, fire-resistant phosphate ester and chlorinated hydrocarbon fluids, many chemicals
Silicone VMQ	S 604-70	70 Shore A rust brown	For high temperatures, hot air, oxygen. Only for use as a static seal.

Parbak® Back-up Rings

Prevent extrusion in high-pressure applications and help retain lubricant, extending O-ring life.

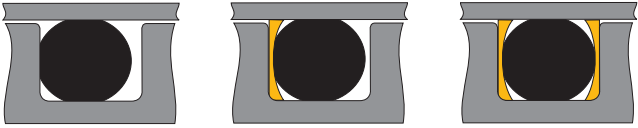

Parbak standard sizes series 8-xxx correspond to O-rings in the 2-xxx series e.g. 8-211, N 300-90 is fitted with the O-ring 2-211, N 674-70.

ParCoat® - The smooth approach to O-ring assembly

ParCoat®-treated O-rings enable frictionless automatic assembly with only minimal exertion of force. During the feeding process, the rings will not stick together. Prior to installation, they can be elongated by more than 150 %, depending on type without causing the anti-friction coating to break or tear.

Fitting components with uncoated O-rings, on the other hand, often requires assembly pressures to be exerted that are twice as high as those needed for ParCoat®-treated seals. Such high pressures may result in seal damage and jamming of assembly components. Conventional surface treatment and coating techniques, such as oiling, improve the sliding ability of the seals only insufficiently, while soiling the assembly components. Defects during the assembly process lead to additional costs for inspections and rework which clearly exceed the relatively small extra charge for ParCoat®-treated O-rings.

Parker's developed ParCoat® EH (standard) solution is a polymer film of merely a few micro-metres of thickness with outstanding sliding properties that is applied to the seal without degrading the elasticity of the basic compound. Depending on the contact medium, the coating may disintegrate into tiny particles some time after assembly. This disintegration will neither contaminate the medium nor lead to any malfunctions. Exposure trials involving three different test media, followed by a subsequent particle count, have confirmed that there is no difference between the media before and after exposure to ParCoat®.

Furthermore, the coating is transparent, enabling the elastomers to be identified by their specific colours, thus precluding the risk of mix-ups.

Typical areas of application are first, automatic and multiple assembly processes. Due to its minimal thickness, e.g. ParCoat® EH is not suitable for achieving permanent improvements of sliding ability in dynamic sealing applications.

ParCoat® surface treatment has been integrated into regular manufacturing processes, thus ensuring full-scale in-process controls, flexibility and short lead times. Parker produces coated O-rings from nearly all compounds.

Benefits

- Clearly reduced frictional forces
- No damage to seals during installation or assembly
- Faster, more cost-efficient assembly process
- Reduction of gaspermeability
- Seals will not stick together in automatic feeding processes
- No soiling or contamination
- Translucent ParCoat® treated O-rings insures no risk of mix-ups as basic elastomer compound colour remains visible
- Longation capacity above 150 %, depending on type
- Suitable for nearly all standard elastomer types* For LSR not all coatings applicable
- In different colours available

Application examples

Automotive engineering

- Air-conditioning lines
- Fuel system quick couplings
- Sensors, electrical connections

Industrial applications

- Instrumentation, fittings, fixtures
- Plug connectors
- Meters

ParCoat® Surface Treatment Processes

ParCoat® Type	Process	Coating thickness [µm]	Appearance	Typical application			Preferred compounds	Contamination feeding	Colour
				- : not recommended	0 : moderately suitable	+: suitable			
				Feeding	Assembly	Multiple assembly			
ParCoat® EH	Elastomer resin	< 5	solid, dry	++	++	+	all	no	translucent
ParCoat® SIH	Multi component varnish	5-30	solid, dry	++	++	+	EPDM NBR FKM VMQ	no	black, translucent
ParCoat® LST	Varnish standard	5-30	solid, dry	++	++	+	EPDM NBR FKM VMQ	no	translucent, satinated
ParCoat® SFR	Varnish (silicone free)	5-10	solid, dry	++	++	+	EPDM NBR FKM VMQ	no	milky, translucent
ParCoat® PLU	Plasmapolymerization USP	-	solid, dry	++	++	+	EPDM NBR VMQ	no	like basic compound
ParCoat® PLS	Plasmapolymerization standard	-	solid, dry	+	+	+	EPDM NBR VMQ	no	like basic compound
ParCoat® HA	Halogenation/Chlorination	-	solid, dry	+	+	+	unsaturated, e.g. NBR	no	like basic compound
ParCoat® TFE	PTFE-coating	25-40	solid, dry	++	++	++	all	no	grey and other colours
ParCoat® SIE	Si-emulsion	-	oily	+	0	+	all, except VMQ	high	translucent
ParCoat® FDA	Varnish (silicone free)	20-30	solid, dry	++	+	+	all	no	translucent
ParCoat® KTW	Elastomer resin	< 5	solid, dry	++	+	+	EPDM HNBR NBR FKM FVMQ	no	translucent

Further ParCoat® types on demand.

Ordering example: O-Ring 2-214 N674-70 / ParCoat® EH

O-Ring Material Offering

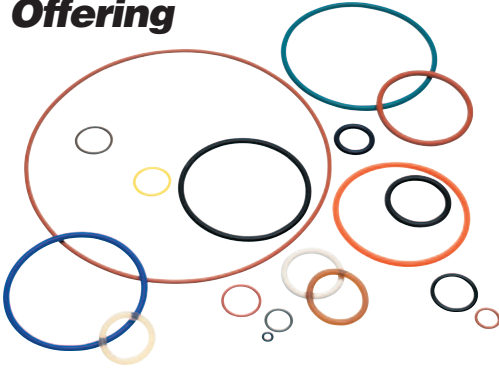

Compounds

O-rings can be molded in a wide range of compounds in hardnesses from 40 to 90 Shore A. These materials include:

- Nitrile-Butadiene (NBR)
- Chloroprene (CR)
- Ethylene Propylene (EPDM)
- Fluorosilicone (FVMQ)
- Perfluoroelastomer (FFKM)
- Silicone (VMQ)
- Fluorocarbon (FKM)
- Hydrogenated NBR (HNBR)
- Polyacrylate (ACM)
- Liquid Silicone (LSR)

Parker O-ring compounds are formulated to meet the most stringent industry standards, including FDA, USP, KTW, DVGW, BAM, WRAS (WRC), NSF, Underwriters Laboratories (UL), Military (MIL-SPEC), Aerospace (AMS), and many customer-specific requirements.

Parker O-Ring Compound Numbering Systems

Note: There are two types of nomenclature used to reference Parker O-Ring products. See tables below for description of these types.

TYPE I		
N	0674	-70
Polymer Code (Single Letter)	Sequence Number (four digits)	Durometer Indicator (two digits)

TYPE II		
FF	350	-75
Polymer Code (two Letter)	Sequence Number (three digits)	Durometer Indicator (two digits)

Polymer Code

A Polyacrylate	N Nitrile (Buna N) and HNBR
C Neoprene (Chloroprene)	S Silicone
E Ethylene Propylene	V Fluorocarbon, Hifluor [®] , Parofluor [™]
FF Parofluor ULTRA [™]	
L Fluorosilicone	

DUROMETER INDICATOR (HARDNESS)

-40	40 ±5	Shore A Durometer
-45	45 ±5	Shore A Durometer
-50	50 ±5	Shore A Durometer
-55	55 ±5	Shore A Durometer
-60	60 ±5	Shore A Durometer
-65	65 ±5	Shore A Durometer
-70	70 ±5	Shore A Durometer
-75	75 ±5	Shore A Durometer
-80	80 ±5	Shore A Durometer
-85	85 ±5	Shore A Durometer
-90	90 ±5	Shore A Durometer

COMPOUND	REMARKS / APPLICATIONS	TEMP. RANGE (STATIC)	COLOR
----------	------------------------	----------------------	-------

POLYACRYLATE (ACM)

ACM (acrylic rubber) has good resistance to mineral oil, oxygen and ozone. The water compatibility and cold flexibility of ACM are considerably worse than those with NBR.

A 3872-70	ACM70; Euro-Standard-Compound	-20°C +150°C	BLACK
A 8531-80	ACM80; Euro-Standard-Compound	-20°C +150°C	BLACK

POLYCHLOROPRENE RUBBER (CR)

Also known by the tradename Neoprene, polychloroprene was the first synthetic rubber and exhibits generally good ozone, aging, and chemical resistance. It has good mechanical properties over a wide temperature range.

C 557-70	Standard 70 Shore CR; good aging and salt water resistance, often used in refrigerant (e.g. R 134a or R22).	-40°C +100°C	BLACK
C 944-70	Col-O-Ring-Compound	-40°C +100°C	RED
C 3721-70	CR70, Euro-Standard-Compound	-35°C +100°C	BLACK

The temperature ranges given are only valid where elastomer medium compatibility is absolute. Recommendations in the column remarks / applications on application design and material selection are based on available technical data and are offered as suggestions only. Each user should make his own tests to determine the suitability for his own particular use. Parker offers no express or implied warranties concerning the form, fit, or function of a product in any application.

COMPOUND	REMARKS / APPLICATIONS	TEMP. RANGE (STATIC)	COLOR
ETHYLENE PROPYLENE RUBBER (EPDM)			
EPDM is a terpolymer of ethylene, propylene, and a diene third monomer used for cross-linking.			
E 529-60	Standard 60 Shore EPDM	-50°C +150°C	BLACK
E 540-80*	Global-Standard-Compound. Good Compression-Set. Steam (to 200°C), Hot water, Air (to 150°C), diluted acids, fire-resistant hydraulic fluids with phosphateester base. Brake fluids with non-mineral oil base. Important! Not compatible with mineral oil	-50°C +150°C	BLACK
E 3609-70	Global-standard-compound, KTW, WRAS, W270 approvals	-50°C +150°C	BLACK
E 3678-80	Col-O-Ring-Compound	-50°C +150°C	VIOLET
E 3704-70	EPDM70, for industrial cooling water applications, Euro-Standard-Compound	-50°C +150°C	BLACK
E 3804-90	Standard 90 Shore EPDM; Parbak-Compound	-50°C +150°C	BLACK
E 3809-80	EPDM80, Euro-Standard-Compound	-50°C +150°C	BLACK
E 8556-70	For industrial cooling water applications, improved aging resistance	-50°C +150°C	BLACK
E 8743-70	FDA-Compound, for food application	-50°C +150°C	BLACK
E 8780-70	Standard 80 Shore EPDM for drinking water application with KTW, WRAS, W 270, EN 681-1 and W 534 approval	-50°C +150°C	BLACK
E 8790-70	Standard 70 Shore EPDM for drinking water application with KTW, WRAS, W 270, EN 681-1, W 534, KIWA, NSF 61 and ACS approval	-50°C +150°C	BLACK

*bold printed compounds are 2-xxx standard and available ex-stock.

The temperature ranges given are only valid where elastomer medium compatibility is absolute. Recommendations in the column remarks / applications on application design and material selection are based on available technical data and are offered as suggestions only. Each user should make his own tests to determine the suitability for his own particular use. Parker offers no express or implied warranties concerning the form, fit, or function of a product in any application.

COMPOUND	REMARKS / APPLICATIONS	TEMP. RANGE (STATIC)	COLOR
NITRILE-BUTADIENE (NBR)			
Nitrile rubber (NBR) is the general term for acrylonitrile-butadiene terpolymer. The acrylonitrile content of nitrile sealing compounds varies considerably (18 to 50%). Polymers with higher ACN content exhibit less swell in gasoline and aromatic solvents, while lower ACN polymers exhibit better compression set and low temperature flexibility. Polymer is also called Buna-N.			
N 525-60	Standard 60 Shore NBR	-35°C +100°C	BLACK
N 552-90*	Standard 90 Shore NBR	-30°C +100°C	BLACK
N 674-70*	Global-Standard-Compound, generally suited for hydraulic and pneumatic systems. Compatible with hydraulic oil, water/glycol (HFC fluids) and oil in water emulsions (HFA). Animal, mineral and vegetable oils, fuels, heavy oil	-35°C +100°C	BLACK
N 3505-50	Improved ozone + weather-proof resistance	-35°C +100°C	BLACK
N 3575-75	Low temperature NBR with improved oilresistance	-50°C +100°C	BLACK
N 3578-80	Standard 80 Shore NBR	-40°C +100°C	BLACK
N 3593-70	NBR70, Euro-Standard-Compound	-30°C +100°C	BLACK
N 3594-50	NBR50, Euro-Standard-Compound	-30°C +100°C	BLACK
N 3596-60	NBR60, Euro-Standard-Compound	-30°C +100°C	BLACK
N 3597-70	NBR70, Euro-Standard-Compound	-30°C +100°C	BLACK
N 3598-80	NBR80, Euro-Standard-Compound	-30°C +100°C	BLACK
N 3599-90	NBR90, Euro-Standard-Compound	-30°C +100°C	BLACK
N 3829-70	KTW-Drinking water approval	-30°C +100°C	BLACK
N 8676-70	Improved ozone resistance NBR, Euro-Standard-Compound	-35°C +100°C	BLACK

*bold printed compounds are 2-xxx standard and available ex-stock.

The temperature ranges given are only valid where elastomer medium compatibility is absolute. Recommendations in the column remarks / applications on application design and material selection are based on available technical data and are offered as suggestions only. Each user should make his own tests to determine the suitability for his own particular use. Parker offers no express or implied warranties concerning the form, fit, or function of a product in any application.

COMPOUND	REMARKS / APPLICATIONS	TEMP. RANGE (STATIC)	COLOR
HYDROGENATED NBR (HNBR)			
Hydrogenated NBR was developed as an air-resistant variant of nitrile rubber. In HNBR, the carbon-carbon double bonds in the main polymer chain are saturated with hydrogen atoms in a process called "hydrogenation" that improves the material's thermal stability and oxidation resistance.			
N 3510-85	Standard 85 Shore HNBR, black	-35°C +150°C	BLACK
N 3512-90	Standard 90 Shore HNBR, black	-35°C +150°C	BLACK
N 3554-75	Standard 75 Shore HNBR	-35°C +150°C	LIGHT-GREEN
N 3573-75	Standard 75 Shore HNBR, black	-35°C +150°C	BLACK
N 3723-80	HNBR80, Euro-Standard-Compound	-35°C +150°C	BLACK
N 3813-70	Low temperature HNBR	-40°C +150°C	BLACK
N 3831-70	HNBR70, Euro-Standard-Compound	-35°C +150°C	BLACK
N 3837-85	Standard 85 Shore HNBR, green	-35°C +150°C	GREEN
N 8505-70	Suitable for Biodiesel (RME) applications up to +80°C	-35°C +150°C	GREEN
N 8570-60	HNBR60, Euro-Standard-Compound	-35°C +150°C	BLACK
N 8680-90	Low temperature HNBR	-40°C +150°C	BLACK
N 8888-70	Compound for gas- and water application with EN 549, EN 681-1, KTW, VP614, VP406 approval	-35°C +150°C	YELLOW

The temperature ranges given are only valid where elastomer medium compatibility is absolute. Recommendations in the column remarks / applications on application design and material selection are based on available technical data and are offered as suggestions only. Each user should make his own tests to determine the suitability for his own particular use. Parker offers no express or implied warranties concerning the form, fit, or function of a product in any application.

COMPOUND	REMARKS / APPLICATIONS	TEMP. RANGE (STATIC)	COLOR
----------	------------------------	----------------------	-------

SILICONE RUBBER (VMQ)

Silicone elastomers have relatively low tensile strength, poor tear and wear resistance. Silicones also possess good insulating properties and tend to be physiologically neutral.

S 595-50	Standard 50 Shore VMQ	-55°C +200°C	RED
S 604-70	Global-Standard-Compound, Col-O-Ring-Compound. Hot air (to 210°C), oxygenwater (to 100°C). Only suitable as static seal	-55°C +200°C	RED
S 613-60	Standard 60 Shore VMQ	-55°C +200°C	RED
S 614-80	Global-Standard-Compound, 80 Shore	-55°C +200°C	RED

LIQUID SILICONE RUBBER (LSR)

Liquid Silicone Rubber (LSR) offer great advantage producing efficient high quantity silicone parts.

Flash less production gives opportunities for difficult molded shapes.

I.E. for fastidious medical or automotive applications.

S 3693-50	Standard 50 Shore LSR	-50°C +200°C	RUST
S 3695-60	Standard 60 Shore LSR	-50°C +200°C	RUST
S 3697-40	Standard 40 Shore LSR	-50°C +200°C	RUST
S 3698-70	Standard 70 Shore LSR	-50°C +200°C	RUST

The temperature ranges given are only valid where elastomer medium compatibility is absolute. Recommendations in the column remarks / applications on application design and material selection are based on available technical data and are offered as suggestions only. Each user should make his own tests to determine the suitability for his own particular use. Parker offers no express or implied warranties concerning the form, fit, or function of a product in any application.

COMPOUND	REMARKS / APPLICATIONS	TEMP. RANGE (STATIC)	COLOR
FLUOROSILICONE (FVMQ) Fluorosilicone is a silicone polymer chain with fluorinated side-chains for improved oil and fuel resistance. The mechanical and physical properties are very similar to those of silicone.			
L 677-70	Col-O-Ring- Compound, for high temperature, good low temperature resistance, mostly fitted where fuel and oil resistance is important, e.g. in aircraft	-60°C +170°C	BLUE
L 806-80	Approvals for military and aerospace applications	-60°C +170°C	BLUE
L 3355-70	70 Shore Fluorsilicon, yellow	-60°C +170°C	YELLOW
L 8559-70	Standard 70 Shore FVMQ	-60°C +170°C	BLUE
L 8585-80	Standard 80 Shore FVMQ; approvals for aerospace applications	-60°C +170°C	BLUE

The temperature ranges given are only valid where elastomer medium compatibility is absolute. Recommendations in the column remarks / applications on application design and material selection are based on available technical data and are offered as suggestions only. Each user should make his own tests to determine the suitability for his own particular use. Parker offers no express or implied warranties concerning the form, fit, or function of a product in any application.

COMPOUND	REMARKS / APPLICATIONS	TEMP. RANGE (STATIC)	COLOR
FLUOROCARBON (FKM)			
Fluorocarbon (FKM) has excellent resistance to high temperatures and a broad range of chemicals. Permeability and compression set are excellent.			
V 709-90	Standard 90 Shore FKM	-25°C +200°C	BLACK
V 747-75*	Global-standard-compound, for high temperatures, hot oil, many chemicals, fire-resistant fluids with phosphate-ester and chlorinated hydrocarbon base. Copolymer.	-25°C +200°C	BLACK
V 763-60	60 Shore FKM, brown	-25°C +200°C	BROWN
V 884-75	Col-O-Ring-Compound; Copolymer	-25°C +200°C	BROWN
V 894-90	Col-O-Ring-Compound	-25°C +200°C	BROWN
V 3642-75	Terpolymer.	-25°C +200°C	BLACK
V 3670-70	70 Shore FKM, green	-25°C +200°C	GREEN
V 3681-80	80 Shore FKM, green	-25°C +200°C	GREEN
V 3701-70	FKM70; Euro-Standard-Compound	-25°C +200°C	BLACK
V 3736-75	Terpolymer, improved low temperature resistance	-28°C +200°C	BLACK
V 3738-75	High fluorinated FKM	-20°C +200°C	BLACK
V 8521-75	FKM75, red, Euro-Standard-Compound	-25°C +200°C	RED
V 8592-75	Low temperature FKM	-40°C +200°C	BLUE
V 8688-75	Low temperature FKM with improved chemical resistance	-35°C +200°C	BLACK
V 8703-75	Improved low temperature resistance, suitable for Biodiesel (RME) applications	-30°C +200°C	BLACK
V 8722-75	Improved resistance against water/glycol and acids	-25°C +200°C	BLACK
V 8750-70	FDA-Compound, food application	-25°C +200°C	BLACK

*bold printed compounds are 2-xxx standard and available ex-stock.

The temperature ranges given are only valid where elastomer medium compatibility is absolute. Recommendations in the column remarks / applications on application design and material selection are based on available technical data and are offered as suggestions only. Each user should make his own tests to determine the suitability for his own particular use. Parker offers no express or implied warranties concerning the form, fit, or function of a product in any application.

HiFluor®-sealing compounds:

Combining resistance with resilience

HiFluor® offers versatile application solution in all industrial disciplines – from the conventional o-ring in standard dimension (imperial or metric), available within a short period, to diaphragms and engineered components based on customer drawings and can be processed in rubber-metal composites as well.



COMPOUND	REMARKS / APPLICATIONS	TEMP. RANGE (STATIC)	COLOR
HIGH PERFORMANCE FLUOROELASTOMERS (HiFluor®)			
HiFluor® is Parker's tradename for high performance fluoroelastomers – materials that "bridge the gap" between traditional fluorocarbon and perfluoroelastomer.			
V 3819-75	Extremely low compression set at cyclical temperatures. Excellent availability in Parker standard dimensions.	-25°C +250°C	BLACK
V 8534-90	Improved resistance to explosive decompression and gap extrusion. Off-shore and petrochemical applications.	-25°C +250°C	BLACK
V 8730-70	Food industry applications. Meets FDA CFR21 NR. 177.2600 requirements. Particularly suitable for use with high processing temperatures and aggressive media.	-25°C +250°C	WHITE
V 3852-65	Preferably used for moulded functional components and membranes/diaphragms.	-25°C +250°C	BLACK
V 8789-55	Sealing applications with reduced deforming force.	-25°C +250°C	BLACK
V 8752-65	Low-temperature high-performance elastomer with broad chemical resistance.	-60°C +200°C	BLACK

The temperature ranges given are only valid where elastomer medium compatibility is absolute. Recommendations in the column remarks / applications on application design and material selection are based on available technical data and are offered as suggestions only. Each user should make his own tests to determine the suitability for his own particular use. Parker offers no express or implied warranties concerning the form, fit, or function of a product in any application.

HiFluor® is a trademark of Parker Hannifin Corporation



PAROFLUOR®

Advanced Perfluorinated Elastomers

What is Parofluor®?

The Parofluor Series consists of advanced perfluorinated elastomers (FFKMs) developed and produced exclusively by Parker Hannifin. Parofluor materials exhibit outstanding retained resiliency as compared with other perfluorinated elastomers, because they're formulated specifically for use in the most demanding sealing applications.

PAROFLUOR®
 Perfluoroelastomer Seals

QUANTUM
 P A R O F L U O R

O-RING MATERIAL OFFERING

COMPOUND	REMARKS / APPLICATIONS	TEMP. RANGE (STATIC)	COLOR
----------	------------------------	----------------------	-------

PERFLUOROELASTOMER (Parofluor®)

Perfluoroelastomer is a rubber version of PTFE. Available from Parker under the trade-names Parofluor®, Parofluor Quantum®, Parofluor ULTRA® and Parofluor Micro®

V 3862-75	Standard 70 Shore Parofluor®, good resistance in hot water, for wet processes in semiconductor applications	-15 °C +260°C	BLACK
V 8545-75	Global-Standard-Parofluor®, best compound for hot water and steam applications	-15 °C +300°C	BLACK
V 8562-75	Global-Standard-Parofluor®, for high temperature-plasma-applications, dry applications in semiconductor industries	-15 °C +300°C	WHITE
V 8581-90	90 Shore Parofluor®	-15 °C +300°C	WHITE
V 8588-90	90 Shore Parofluor®	-15 °C +260°C	BLACK
V 8742-70	70 Shore Parofluor®	-15 °C +300°C	WHITE
V 8800-75	75 Shore Parofluor®	-15 °C +320°C	BLACK
V 8810-75	75 Shore Parofluor®	-15 °C +300°C	BLACK

Parofluor Quantum®

V 8787-75	75 Shore Parofluor Quantum® optimized paint, varnish and solvent stability	-20 °C +230°C	BLACK
V 8844-75	75 Shore Parofluor Quantum® optimized paint, varnish and solvent stability	-20 °C +230°C	WHITE

The temperature ranges given are only valid where elastomer medium compatibility is absolute. Recommendations in the column remarks / applications on application design and material selection are based on available technical data and are offered as suggestions only. Each user should make his own tests to determine the suitability for his own particular use. Parker offers no express or implied warranties concerning the form, fit, or function of a product in any application.

Parofluor®, Parofluor Quantum®, Parofluor ULTRA® und Parofluor Micro® is a trademark of Parker Hannifin Corporation



PAROFLUOR®

Advanced Perfluorinated Elastomers

What is Parofluor ULTRA®

Parofluor ULTRA is the next generation of high performance perfluorinated elastomers within the Parofluor family. These materials offer ultra high temperature resistance up to 320°C (608°F), broad chemical resistance and ultra high purity.



COMPOUND	REMARKS / APPLICATIONS	TEMP. RANGE (STATIC)	COLOR
PERFLUOR ELASTOMER (Parofluor ULTRA®)			
Perfluoroelastomer is a rubber version of PTFE. Available from Parker under the tradenames Parofluor®, Parofluor Quantum®, Parofluor ULTRA® and Parofluor Micro®			
FF 200-75	75 Shore high temperature Parofluor ULTRA®	-15°C +320°C	BLACK
FF 350-75	High purity, high temperature Parofluor ULTRA® for plasma applications	-15°C +316°C	WHITE
FF 356-75	75 Shore high temperature Parofluor ULTRA®	-15°C +316°C	WHITE
FF 202-90	90 Shore high temperature Parofluor ULTRA®	-15°C +320°C	BLACK
Parofluor Micro®			
V 8712-75	75 Shore high purity Parofluor Micro®	-15°C +250°C	TRANSLUCENT
V 8801-75	75 Shore high purity Parofluor Micro®	-15°C +250°C	WHITE

Application Profile of Hifluor® and Parofluor® Elastomers

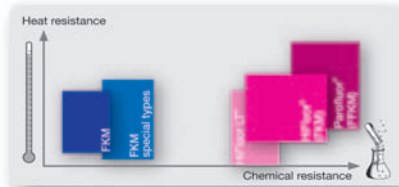

The temperature ranges given are only valid where elastomer medium compatibility is absolute. Recommendations in the column remarks / applications on application design and material selection are based on available technical data and are offered as suggestions only. Each user should make his own tests to determine the suitability for his own particular use. Parker offers no express or implied warranties concerning the form, fit, or function of a product in any application.

Underwriters Laboratories Approved Services

SERVICE CODE	Fire Extinguishing Agents Gasoline Gasoline/Alcohol Blends Naptha or Kerosene MPS Gas MFG or Natural Gas Diesel Fuel, Fuel Oil, Lubricating Oil Heated Fuel Oil Anhydrous Ammonia LP-Gas Laundry Detergents Dishwashing Detergents Suitable for use in UL 1081 Suitable for use in UL 262 applications Suitable for use in UL 25 gasket applications Dry Chemical, Carbon Dioxide, Water												
	A	B	C	D	E	F	G	H	I	J	K	L	M
N 0674-70	■			■		■	■	■	■	■			
V 0747-75		■		■		■	■	■		■			
V 0884-75		■	■	■			■						

O-RING MATERIAL OFFERING

Seals for Gas Supply and Appliances

The following Parker Hannifin Compounds are approved by the German Association for the given applications:

PARKER HANNIFIN COMPOUND	POLYMER	STANDARD
N 8546-80	NBR	DIN 3535, Part 3
N 8760-70	NBR	DIN 3535, Part 3
V 747-75	FKM	DIN 3535, Part 3
N 674-70	NBR	DIN EN 549 VP 406
N 3506-70	NBR	DIN EN 549
N 3578-80	NBR	DIN EN 549
N 3829-70	NBR	DIN EN 549
N 8662-70	NBR	DIN EN 549
N 8766-70	HNBR	DIN EN 549
N 8888-70	HNBR	DIN EN 549 VP 406 VP 614
S 604-70	VMQ	DIN EN 549
S 3698-70	VMQ	DIN EN 549
V 747-75	FKM	DIN EN 549
V 884-75	FKM	DIN EN 549

Food Industry

Compounds which are to be used in contact with foodstuffs must comply with the law. The BgVV (German Institut for health consumer protection and veterinary medicine) have compiled a list of substances which have no effect on health.

According to BgVV recommendation no. XXI, rubber parts are divided into 4 classes and a special category according to the period of time in contact with the foodstuff.

Silicone is suitable for these applications because of its physiological properties. It is inert, taste and odourfree.

The FDA (Food and Drug Administration, USA) has a list of allowable substance similar to the BgVV list which are non-toxic or carcinogenic. Additionally the FDA requires extraction tests which are carried out by the manufacturer.

Parker Hannifin GmbH have developed compounds which correspond to the FDA requirements.

PARKER COMPOUND	POLYMER	COLOUR	STANDARD
EJ 590-70	EPDM	white	FDA + USP classVI
EJ 595-70	EPDM	white	FDA + USP classVI
E 3609-70	EPDM	black	FDA
E 8743-70	EPDM	black	FDA
E 8780-80	EPDM	black	FDA + BfR
E 8790-70	EPDM	black	FDA + BfR
S 3693-50	LSR	reddish brown	FDA + BfR
S 3695-60	LSR	reddish brown	FDA + BfR
S 3697-40	LSR	reddish brown	FDA + BfR
S 3698-70	LSR	reddish brown	FDA + BfR
V 8722-75	FKM	black	FDA
V 8730-70	Hifluor	white	FDA
V 8742-70	FFKM	white	FDA
V 8750-70	FKM	black	FDA
V 8810-75	FFKM	black	FDA

KTW Approved Compounds

KTW - Drinking Water System Components - is the nationally recognized health effects standard for all devices, components and materials which contact drinking water. Parker's O-Ring Division has developed several materials that are certified to KTW. Many of these materials are approved for use in the United Kingdom (WRAS), and North America (NSF 61) as well as Germany (KTW).

PARKER COMPOUND	POLYMER	WASSER CONTACT TEMP.	STANDARD
E 1549-70	EPDM	90°C	KTW
		85°C	WRAS
		82°C	NSF 61
E 3609-70	EPDM	90°C	KTW
		85°C	WRAS
		82°C	NSF 61
		-	EN 681-1, W 534
E 8780-80	EPDM	90°C	KTW, W270, Ö-Norm B5014-1
		85°C	WRAS
		-	EN 681-1, W 534
E 8790-70	EPDM	90°C	KTW, W270
		85°C	WRAS
		90°C	ACS, KIWA, Ö-Norm B5014-1
		82°C	NSF 61
		-	EN 681-1, W 534
N 3829-70	NBR	90°C	KTW
N 8888-70	HNBR	85°C	KTW
		-	EN 681-1
S 3693-50	LSR	90°C	KTW
S 3695-60	LSR	85°C	KTW
S 3741-60	LSR	85°C	KTW

Aerospace Materials

AMS⁽¹⁾ and NAS⁽²⁾ Rubber Specification Descriptions

RUBBER SPECS	PARKER COMPOUND	HARDNESS	DESCRIPTION TITLE
AMS3201	N0545-40	35-45	Dry Heat Resistance
AMS3205	N0299-50	45-55	Low Temperature Resistance
AMS3208	C0267-50	45-55	Weather Resistant, Chloroprene Type
AMS3209	C1124-70	65-75	Weather Resistant, Chloroprene Type
AMS3212	N0525-60	55-65	Aromatic Fuel Resistant
AMS3220	N0525-60	55-65	General Purpose, Fluid Resistant
AMS3238	B0318-70	65-75	Phosphate-Ester Resistant, Butyl Type
AMS3301	S0469-40	35-45	Silicone, General Purpose
AMS3302	S0595-50	45-55	Silicone, General Purpose
AMS3303	S0613-60	55-65	Silicone, General Purpose
AMS3304	S1224-70 S0604-70	65-75	Silicone, General Purpose
AMS3305	S0614-80	75-85	Silicone, General Purpose
AMS3325	L1223-60 LM152-60	55-65	Fluorosilicone Rubber, Fuel and Oil Resistant
AMS3337	S0383-70	65-75	Silicone, Extreme Low Temperature Resistant
AMS3345	S0899-50	45-55	Silicone Rubber
AMS3357	S1224-70 S0604-70	65-75	Silicone Rubber, Lubricating Oil, Compression Set Resistant
AMS7257	V8545-75, FF200-75	70-80	Sealing Rings, Perfluorocarbon, High Temperature Resistant
AMS7259	V0709-90	85-95	High Temp, Fluid Resistant, Very Low Compression Set FKM
AMS7267	S0355-75	70-80	Silicone, Heat Resistant, Low Compression Set
AMS7271	N0506-65	60-70	Fuel and Low Temperature Resistant

(1) Aerospace Material Specification issued by the Society of Automotive Engineers, Inc.

(2) National Aerospace Standard issued by Aerospace Industries Association of America, Inc.

AMS⁽¹⁾ and NAS⁽²⁾ Rubber Specification Descriptions

RUBBER SPECS	PARKER COMPOUND	HARDNESS	DESCRIPTION TITLE
AMS7272	N0287-70	65-75	Synthetic Lubricant Resistant
AMS7276	V1164-75 V1226-75 V0747-75	70-80	High Temp. Fluid Resistant, Very Low Compression Set FKM
NAS1613	E1267-80,	75-85	Packing, O-ring, Phosphate Ester Resistant
AMS-P-5315	N0602-70	65-75	Packing O-ring, Hydrocarbon Fuel Resistant
AMS-P-5510	N0507-90	85-95	Gasket, Straight Thread Tube Fitting Boss
AMS-R-6855	N0406-60, C1124-70	55-75	Synthetic Rubber Sheets, Strips, Molded or Extruded Shapes, Synthetic Oil Resistant
AMS-R-7362	47-071	65-75	Rubber, Sheet, Molded and Extruded Shapes, Synthetic Oil Resistant
AMS-P-25732	N0304-75	70-80	Packing, Preformed, Petroleum Hydraulic Fluid Resistant, Limited Performance
AMS-R-25988	L1223-60, L1120-70, L1218-80, L1077-75 LM152-60 LM153-70 LM154-75 LM155-80	55-85	Rubber, Fluorosilicone Elastomer, Oil and Fuel Resistant
AMS-R-83248	V1164-75, V1226-75, V0747-75 V0709-90	70-95	Rubber, Fluorocarbon Elastomer, High Temperature Fluid and Compression Set Resistant
AMS-P-83461	N0756-75	70-80	Packings, Preformed, Petroleum Hydraulic Fluid Resistant, Improved Performance
AMS-R-83485	V0835-75	70-80	Rubber, Fluorocarbon Elastomer, Improved Performance at Low Temperatures

(1) Aerospace Material Specification issued by the Society of Automotive Engineers, Inc.

(2) National Aerospace Standard issued by Aerospace Industries Association of America, Inc.

Military Rubber Specifications

Note: In compliance with the Federal Acquisition Streamlining Act (FASA), most of these specifications are being revised to AMS specifications. For the most current information, contact the O-Ring Division.

RUBBER SPECS	PARKER COMPOUND	DESCRIPTION
ZZ-R-765E		Rubber, Silicone
Class	Grade	Temperature Range⁽¹⁾
1a. 1b. 2a. 2b.	50	S0899-50 - 103 to 437°F (-75 to 225°C) Low and High Temperature Resistant, Low Compression Set
1a. 1b	70	S0383-70 - 103 to 437°F (-75 to 225°C) Low Temperature Resistant, Low Compression Set
2a. 2b	80	S0614-80 - 80 to 437°F (-62 to 225°C) High Temperature Resistant, Low Compression Set
2a. 2b	70	S1224-70 - 80 to 437°F (-62 to 225°C) High Temperature Resistant, Low Compression Set S0604-70
MIL-G-1149C - Type I Class 1	Gasket Materials, Synthetic Rubber, 50 and 65 Durometer Hardness C0267-50	(-20 to 212°F) (-29 to 100°C) ⁽¹⁾
MIL-R-3533B - Type I Grade B	Rubber, Synthetic; Sheet, Strip and Molded N0602-70	(-20 to 158°F) (-29 to 70°C) ⁽¹⁾
MIL-P-5315B -	Packing, O-ring, Hydrocarbon Fuel Resistant (Jet Fuels) (Military O-ring series MS29512 and MS29513) N0602-70	(-65 to 160°F) (-54 to 71°C)
MIL-P-5510C -	Gasket, Straight Thread Tube Fitting Boss (MIL-H-5606 Petroleum Based Hydraulic Fluid) N0507-90	(-45 to 160°F) (-43 to 71°C) ⁽¹⁾ (Military O-ring series MS28778)
MIL-R-6855D - Class 1 Grade 60 Class 2 Type B Grade 70	Synthetic Rubber Sheets, Strips, Molded or Extruded Shapes N0406-60 C1124-70	(-65 to 212°F) (-54 to 100°C) ⁽¹⁾ Fuel and Petroleum Oil Resistant Petroleum Oil, Weather and Ozone Resistant

(1) These temperatures are limits for particular tests required by the specifications, but they do not necessarily represent operating temperature limits.

RUBBER SPECS	PARKER COMPOUND	DESCRIPTION
MIL-R-7362D - Types I, II	Rubber, Sheet, Molded and Extruded Shapes, Synthetic Oil Resistant (AMS3021) 47-071	Synthetic, Di-Ester Base Lubricant (-65 to 275°F) (-54 to 135°C) ⁽¹⁾ (Military O-ring series MS29561 and WAS617)
MIL-G-21569B - Class I Class II	Gaskets, Cylinder Liner Seal, Synthetic N0674-70 S0604-70	(Room temperature to 194°F) (RT to 90°C)
MIL-P-25732C -	Packing, Preformed, Petroleum Hydraulic Fluid Resistant (MIL-H-5606) N0304-75	Petroleum Base Hydraulic Fluid (-49 to 230°F) (-45 to 110°C) (Military O-ring series MS28775) N756-75 (-65 bis 275°F) (-54 bis 135°C) ⁽¹⁾
MIL-R-25988 - Type 1, Class 1, Grade 60/3 Type 1, Class 1, Grade 70/1 Type 1, Class 1, Grade 80/4 Type 1, Class 3, Grade 75/2	Rubber Fluorosilicone Elastomer, Oil and Fuel Resistant (MIL-H-5606 Petroleum Base) Hydraulic Fluid, Fuel, Air (-90 to 350°F) (-68 to 176°C) ⁽¹⁾ L1223-60, LM152-60 L1120-70, LM153-70 L1218-80, LM155-80 L1077-75, LM154-75	
MIL-P-82744 -	Packing, Preformed, Otto Fuel Compatible (-65 to 250°F) (-54 to 121°C) E0515-80	
MIL-R-83248C, Type I - Class I Class 2	Rubber, Fluorocarbon Elastomer, High Temperature Fluid and Compression Set Resistant (-15 to 400°F) (-5 to 105°C) V0747-75, V1164-75, V1226-7 V0709-90	
MIL-R-83485	Grade 80 V0835-75 Rubber, fluorocarbon Elastomer, Improved performance @ low Temp	
MIL-P-83461B -	Packings, Preformed, Petroleum Hydraulic Fluid Resistant, Improved Performance N0756-75	(-65 to 275°F) (-54 to 135°C) ⁽¹⁾

(1) These temperatures are limits for particular tests required by the specifications, but they do not necessarily represent operating temperature limits.

AIRBUS Nord-Sud Aviation (NSA)

SPECIFICATION	PARKER COMPOUND	DESCRIPTION
NSA 5512	Special	Bonded Seal
NSA 8200	L 8585-80	Sizes 3-xxx
NSA 8201	E 1267-80	Sizes 3-xxx
NSA 8202	C 3645-80	Sizes 3-xxx
NSA 8203	L 8585-80	Sizes 2-xxx
NSA 8204	E 1267-80	Sizes 2-xxx, NAS 1613, Color Code
NSA 8205	C 3645-80	Sizes 2-xxx
NSA 8206	S 604-70	Sizes 2-xxx
NSA 8207	S 604-70	Sizes 3-xxx
NSA 8213	E 1267-80	Square Ring
NSA 8216	E 1267-80	Square Ring
NSA 8218	E 1267-80	Square Ring
NSA 8671	W 5036	Square Ring, PTFE

Norme Francaise (NF)

SPECIFICATION	PARKER COMPOUND	CATEGORY
NF L17-120	N674-70	20A7
NF L17-241	E1267-80	41B8
NF L17-160	V3642-75	60 C7
NF L17-160	V709-90	60 C9
NF L17-164	V747-75	64C8
NF L17-161	L3747-60	61D6
NF L17-261	L8585-80 blue	61D8
NF L17-261	L1218-80	61D8
NF L17-250-4	S604-70	EN 2261

Compound-Datasheet (WL)

SPECIFICATION	PARKER COMPOUND	SPECIFICATION	PARKER COMPOUND
5.5440	C 365-45	5.5704	V 3670-70
5.5502	S 595-50	5.5707	B 3688-70
5.5600	E 529-65	5.5709	C 557-70
5.5601	N 406-60	5.5710	L 677-70/L 8559-70
5.5602	N 239-60	5.5801	N 3578-80
5.5603	S 613-60	5.5802	E 540-80
5.5612	N 406-60	5.5804	V 747-75
5.5627	N 261-65	5.5808	V 709-90
5.5629	N 525-60	5.5810	N 552-90
5.5655	N 406-60	5.5813	L 806-80
5.5688	L 3747-60	5.5814	S 614-80
5.5701	V 747-75	5.5829	N 755-80
5.5702	N 674-70	5.5855	N 3518-80
5.5703	S 604-70		

Engineering Design Notes

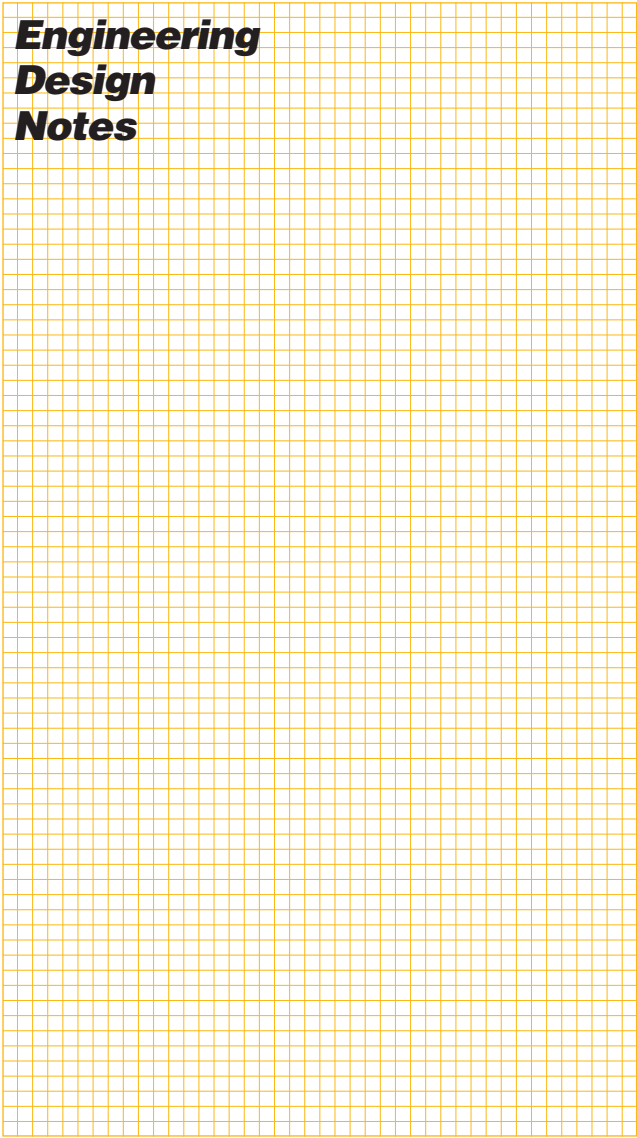

Engineering Tools

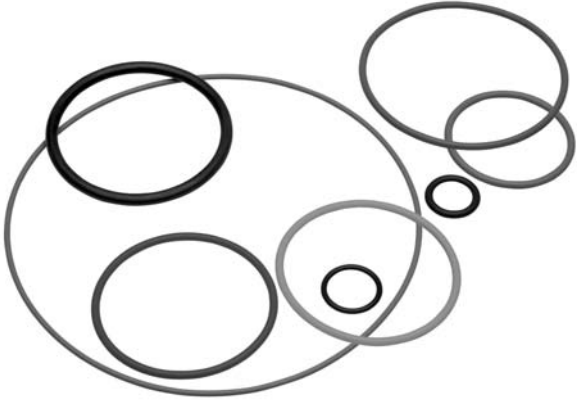

The following charts are included to facilitate engineering analysis.
Additional information is available in the O-Ring Handbook 5705 DE-UK

Compression Load Charts

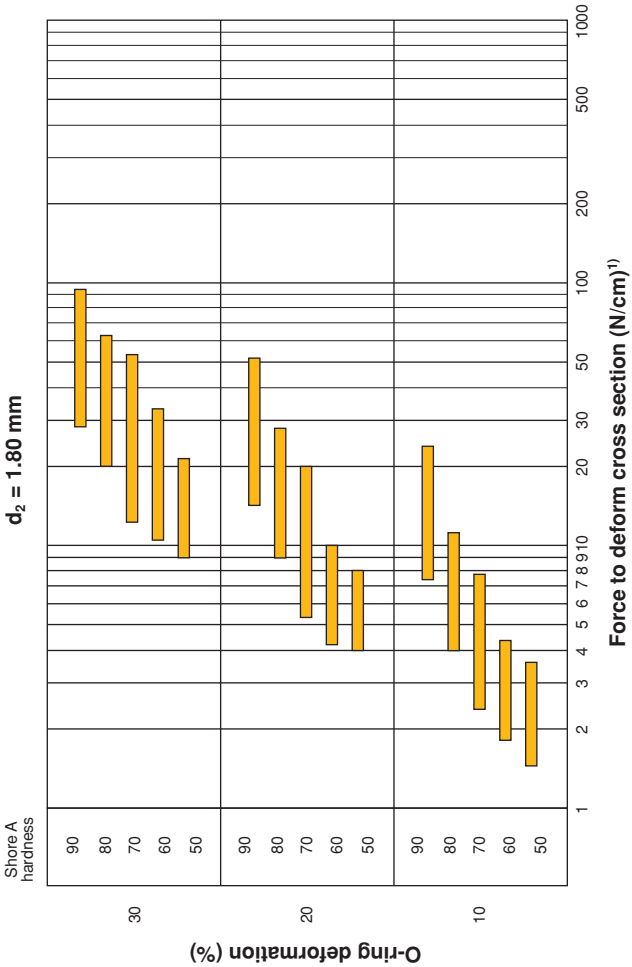

(1) Length in cm of O-ring circumference

Compression Load Charts - Continued

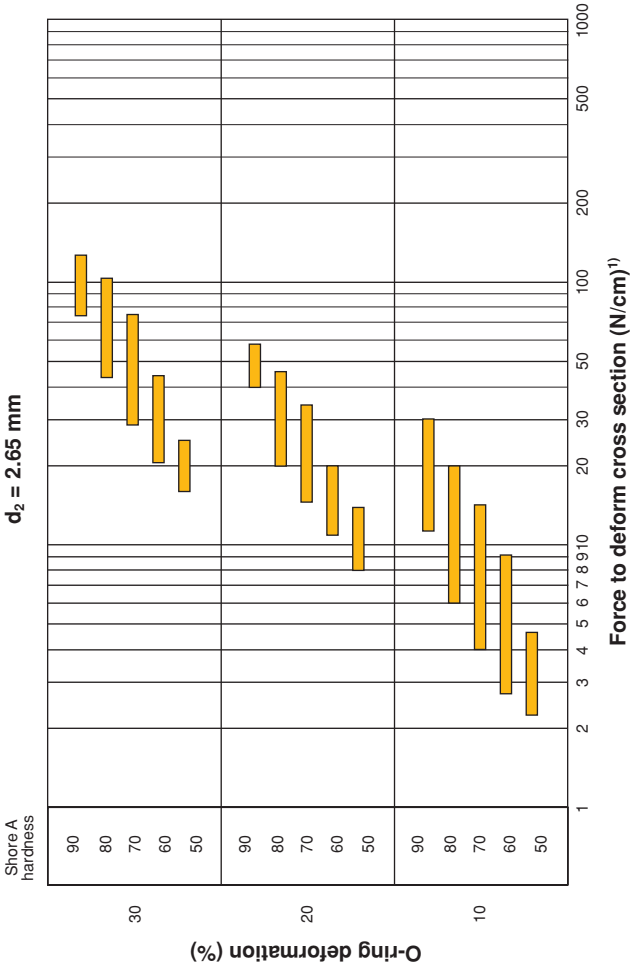

ENGINEERING TOOLS

(1) Length in cm of O-ring circumference

Compression Load Charts - Continued

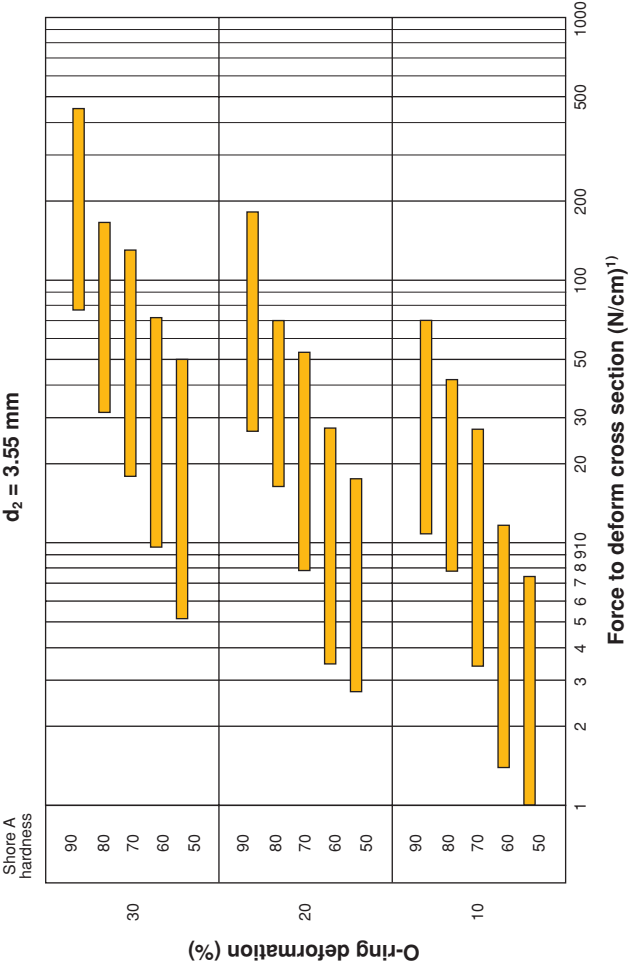

(1) Length in cm of O-ring circumference

Compression Load Charts - Continued

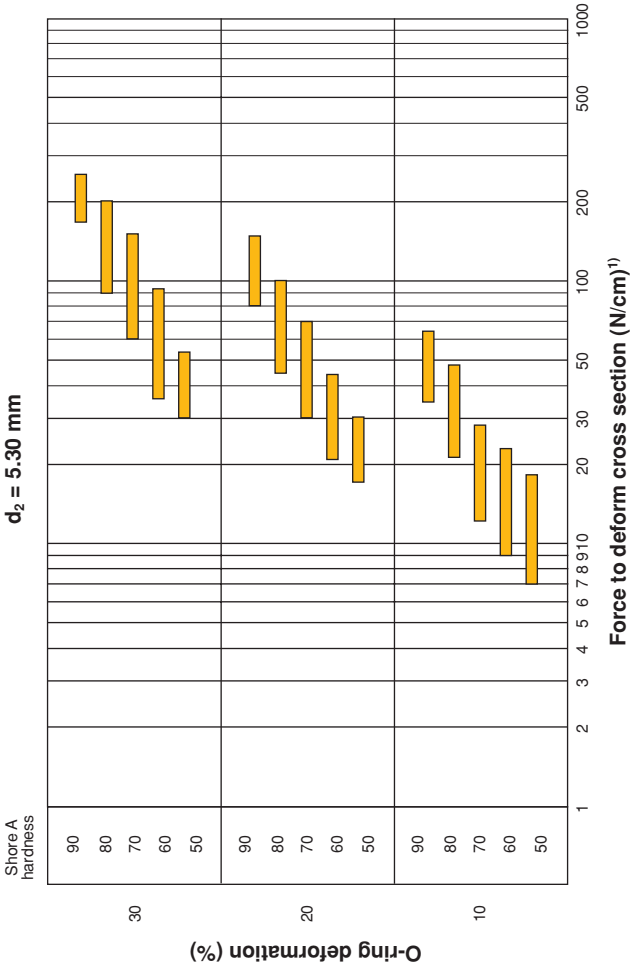

ENGINEERING TOOLS

(1) Length in cm of O-ring circumference

Compression Load Charts - Continued

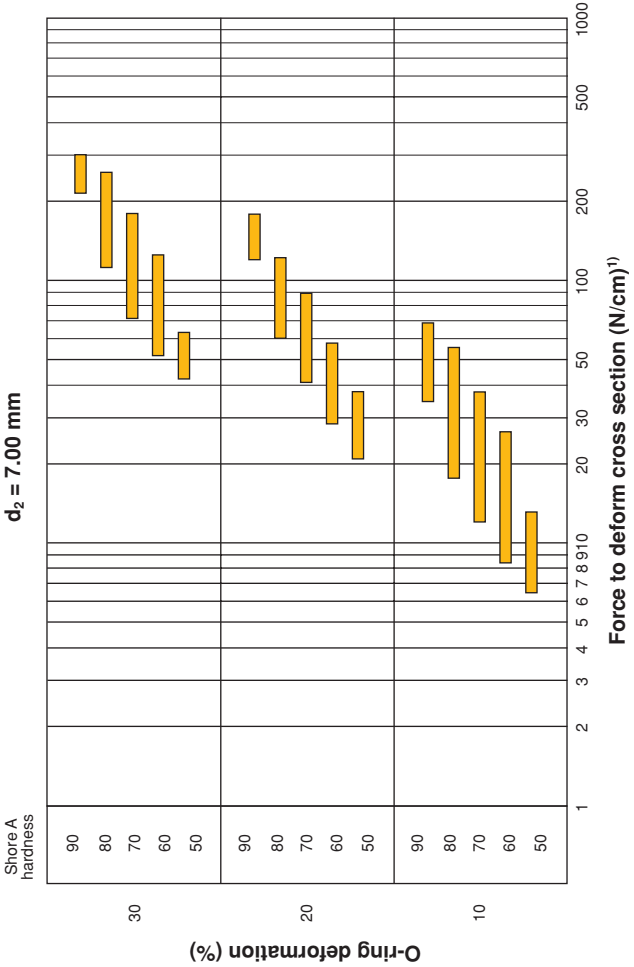

(1) Length in cm of O-ring circumference

Extrusion

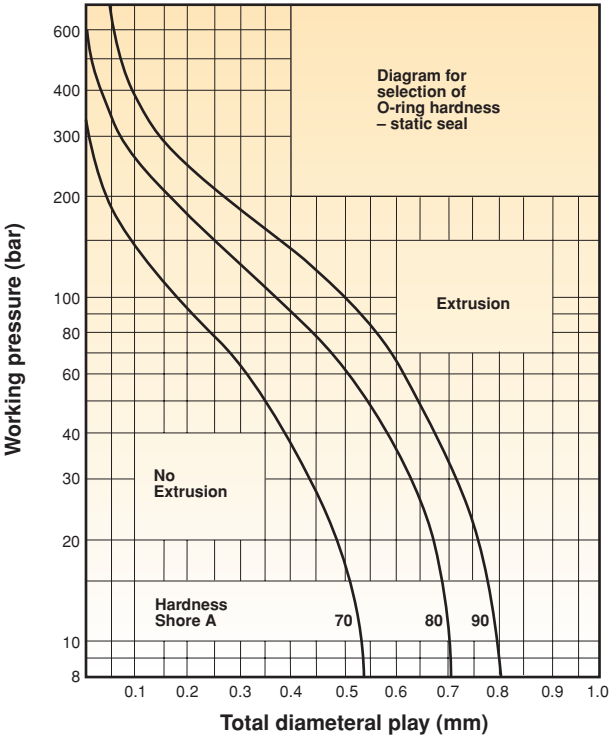

* Reduce the clearance shown by 60% when using silicone or fluorosilicone elastomers.

Basis for Curves

1. 100,000 pressure cycles at the rate of 60 per minute from zero to the indicated pressure.
2. Maximum temperature (i.e., test temperature) 71°C.
3. No back-up rings.
4. Total diametral clearance must include cylinder expansion due to pressure.
5. Apply a reasonable safety factor in practical applications to allow for excessively sharp edges and other imperfections and for higher temperatures.

Engineering Design Notes

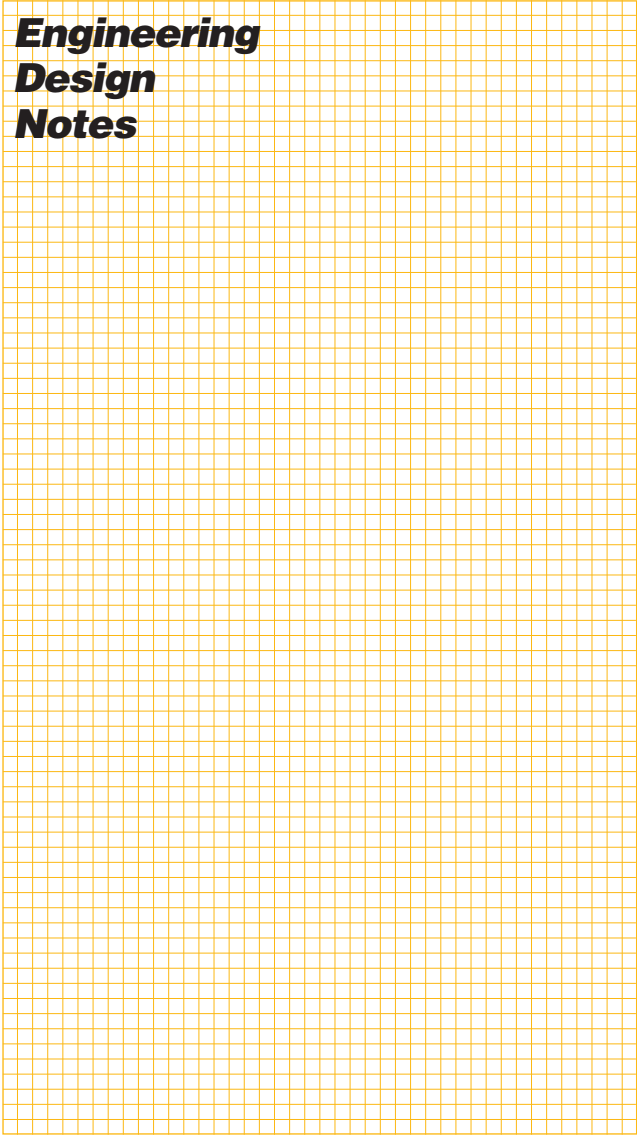

Gland Designs

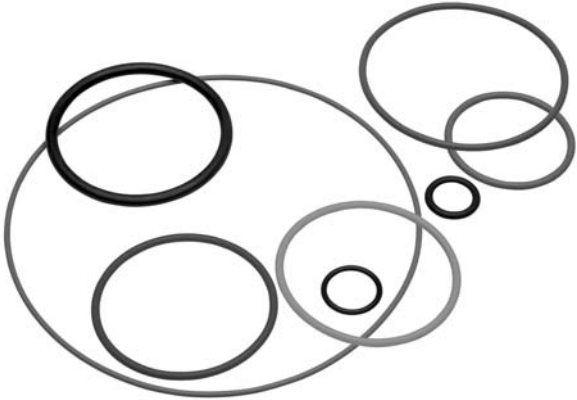

The following charts are included to facilitate engineering analysis. Additional information is available in the O-Ring Handbook 5705 DE-UK

Parker offers O-rings for use in static as well as dynamic sealing applications. Static seals are those where the mating parts of the gland do not have movement relative to each other. These seals include face, radial, dovetail. Examples of these seals and the corresponding design charts are found on pages 38-43. Dynamic seals include reciprocating, floating pneumatic, oscillating, and rotary applications. Dynamic seals are defined by one of the gland parts having movement relative to the other part. Gland design recommendations for a reciprocating seal are provided on pages 44 and 45.

For further design assistance and recommendations, access our Total inPHorm Seal Design software, or contact a Parker O-Ring applications engineer.

Static seal – axial

The O-ring is deformed in the axial direction. Under pressure the O-ring is subjected to a relative movement, it is important to note the pressure direction.

- if pressure acts from inside, then the O-rings outside diameter should be in contact with the gland outside diameter (optimally compressed between 1 and 3 % of circumference).

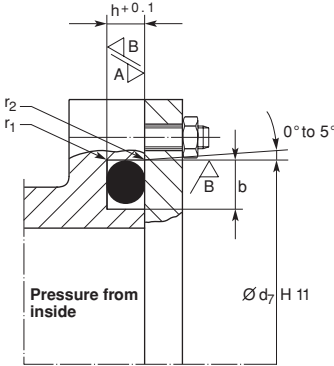

- if pressure acts from outside, then the O-rings inside diameter should be in contact with the internal diameter of the gland (up to 6 % stretched).

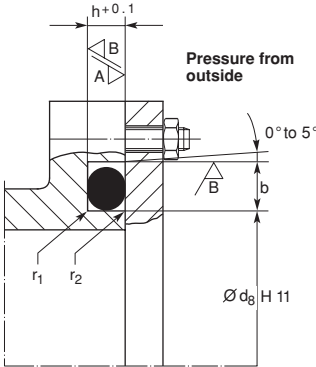

Static seal – axial

Surface roughness – static seal

Surface	Pressure	Surface roughness in μm , load area $t_p > 50\%$	
		R_a	$R_{max.}$
A contact area	non-pulsating	1.6	6.3
	pulsating	0.8	6.3
B gland diameter and sides	non-pulsating	3.2	12.5
	pulsating	1.6	6.3

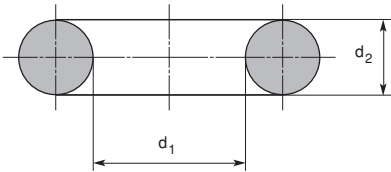

Rectangular gland dimensions – axial deformation

d_2	$h^{+0.10}$	$b^{+0.20}$	r_1	r_2
1.50	1.10	1.90		
1.80	1.30	2.40	0.2	
2.00	1.50	2.60	to	
2.50	2.00	3.20	0.4	
2.65	2.10	3.60		
3.00	2.30	3.90		
3.55	2.80	4.80		
4.00	3.25	5.20	0.4	0.2
5.00	4.00	6.50	to	to
5.30	4.35	7.20	0.8	0.4
6.00	5.00	7.80		
7.00	5.75	9.60		
8.00	6.80	10.40	0.8	
9.00	7.70	11.70	to	
10.00	8.70	13.00	1.2	
12.00	10.60	15.60		

Dimensions in mm. The ISO/DIN recommendations are preferred and are shown here in heavy print.

Static seal – radial

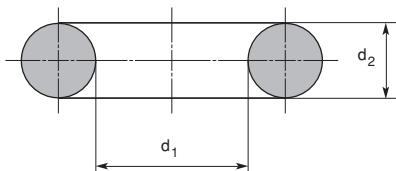

Gland dimensions – radial deformation

d_2	t^*	$b+0.20$	z	r_1	r_2
1.50	1.10	1.90	1.5		
1.80	1.40	2.40	1.5	0.2	
2.00	1.50	2.60	1.5	to	
2.50	2.00	3.20	1.5	0.4	
2.65	2.20	3.60	1.5		
3.00	2.30	3.90	2.0		
3.55	2.90	4.80	2.0		
4.00	3.25	5.20	2.0	0.4	0.1
5.00	4.10	6.50	3.0	to	to
5.30	4.50	7.20	3.0	0.8	0.3
6.00	5.00	7.80	3.0		
7.00	5.90	9.60	3.6		
8.00	6.80	10.40	4.0	0.8	
9.00	7.70	11.70	4.5	to	
10.00	8.70	13.00	4.5	1.2	
12.00	10.60	15.60	4.5		

* The tolerances are taken from $d_3h9 + d_4H8$ or $d_5f7 + d_6H9$
 Dimensions in mm. The ISO/DIN recommendations are preferred and are shown in heavy print.

Surface finish roughness – static seal

Surface	Pressure	Surface roughness in μm , load area $t_p > 50\%$	
		R_a	$R_{max.}$
A contact area	non-pulsating	1.6	6.3
	pulsating	0.8	3.2
B gland diameter and sides	non-pulsating	3.2	12.5
	pulsating	1.6	6.3
C surface finish of leading edge chamfer		3.2	12.5

Static seal – radial

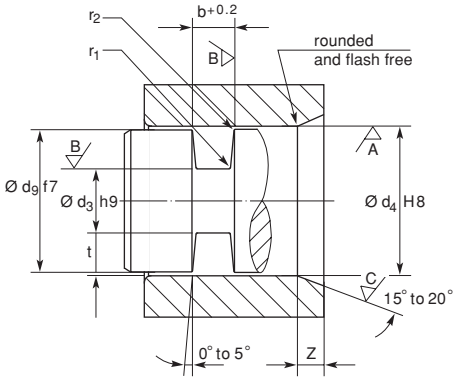

Piston seal

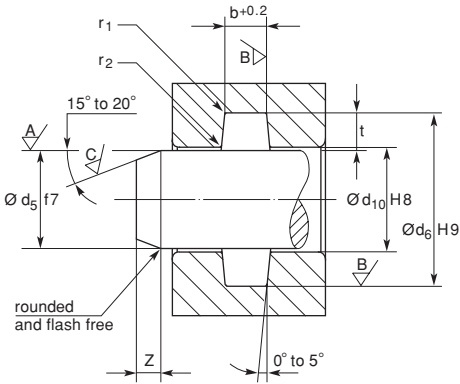

Rod seal

Static seal – dovetail groove

The dovetail groove form is used when it is necessary to hold an O-ring in position; e.g. during surface work, on opening and closing of tooling, where otherwise the O-ring would fall out of the gland.

The machining of the gland is difficult and expensive.

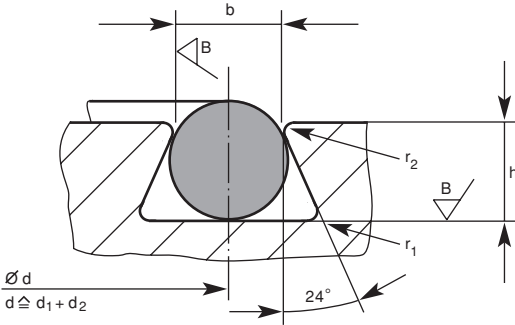

Dovetail gland

d = gland mean diameter

- the gland width is measured before edges are deburred
- the radius r_2 is so selected that the O-ring is not damaged on assembly and so that the O-ring can not be trapped in the gap under high pressure.

Static seal – half dovetail gland

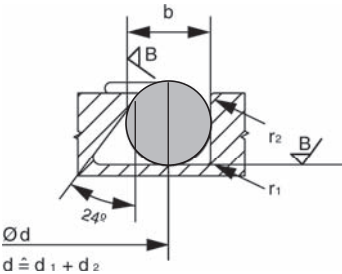

Static seal – dovetail groove

Dovetail gland dimensions

d_2	h	$b^{+0.10}$	r_1	r_2
1.80	1.25+0.05	1.40	0.10	0.40
2.65	2.05+0.05	2.10		
3.55	2.80+0.05	2.85	to	to
5.30	4.55+0.08	4.35		
7.00	5.85+0.08	5.85	0.30	1.60

Dimensions in mm.

Surface roughness – static seal

Surface	Pressure	Surface roughness in μm , load area $t_p > 50\%$	
		R_a	R_{max}
A contact area	non-pulsating	1.6	6.3
	pulsating	0.8	3.2
B gland diameter and sides	non-pulsating	3.2	12.5
	pulsating	1.6	6.3

Half dovetail -gland dimensions

d_2	h	$b^{+0.20}$	Nominal Squeeze %	r_2	r_1
1.78	1.30+0.05	1.60	27	0.1 bis 0.3	0.4 bis 1.60
2.62	2.05+0.05	2.40	22		
3.53	2.85+0.05	3.15	19		
5.33	4.35+0.08	4.80	18		
6.99	5.90+0.08	6.50	16		

Dynamic seal – hydraulic

Surface-finish roughness – reciprocating seal – hydraulic

Surface	Surface roughness in μm , load area $t_p > 50\%$	
	R_a	$R_{max.}$
A Contact area	0.4	1.6
B Gland diameter and sides	1.6	6.3
C Surface finish of leading edge chamfer	3.2	12.5

Gland dimensions – dynamic hydraulic seal

d_2	t^*	$b^{+0.20}$	z	r_1	r_2
1.50	1.30	1.9	1.5		
1.80	1.45	2.4	1.5	0.2	
2.00	1.70	2.6	1.5	to	
2.50	2.10	3.3	1.5	0.4	
2.65	2.20	3.6	1.5		
3.00	2.60	3.9	1.8		0.1
3.55	3.05	4.8	1.8		to
4.00	3.50	5.3	1.8	0.4	0.3
5.00	4.45	6.7	2.7	to	
5.30	4.65	7.1	2.7	0.8	
6.00	5.40	8.0	3.6		
7.00	6.20	9.5	3.6		

* The tolerances is a combination of $d_3h9 + d_4H8$ or $d_5f7 + d_6H9$
 Dimensions in mm. The Iso/DIN recommendations are preferred.

Additional information to the surface-finish-roughness and the gland dimensions of the pneumatic application is available in the Parker Handbook ORD 5705 E

Gland Design Notes

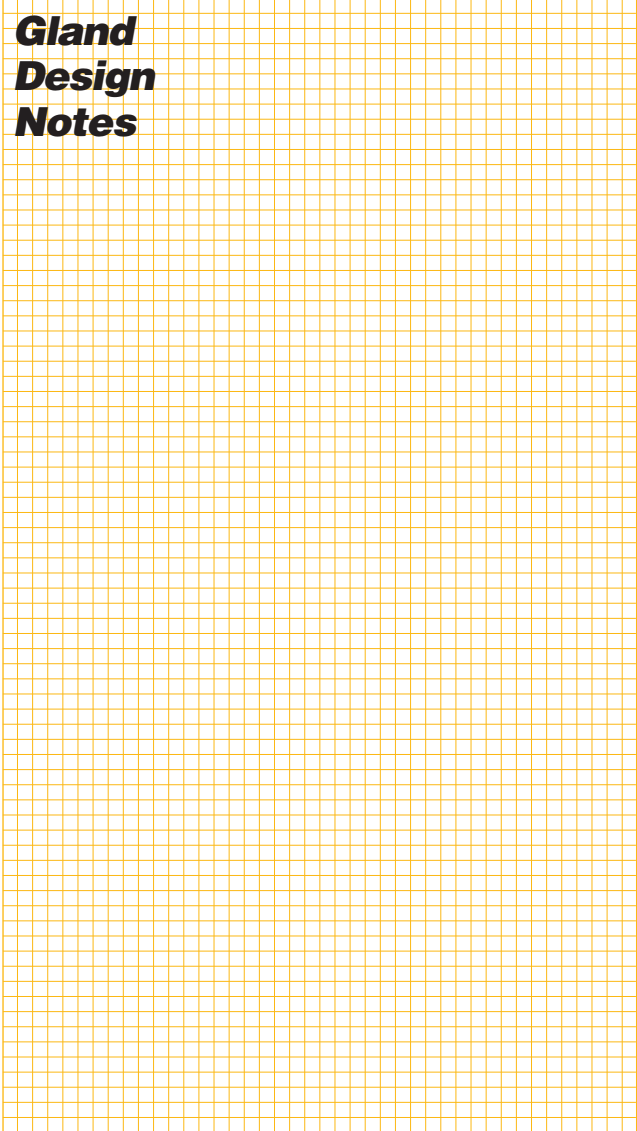

Sizing Charts

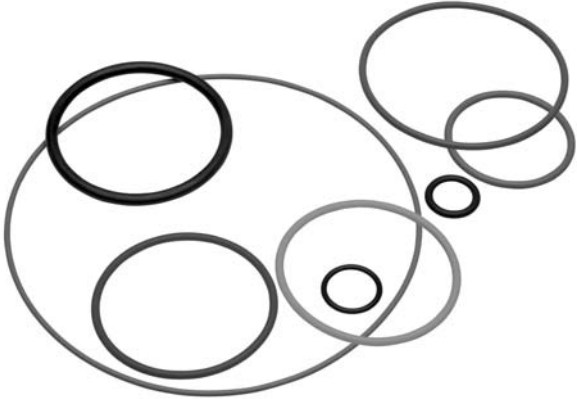

The following charts provide dimensions for standard shrinkage materials only. These correspond to AS568B dimensions. O-Rings manufactured from compounds with different shrinkage rates will provide slightly different dimensions and tolerances when standard tooling is used. Custom tooling may be necessary for some compounds in order to meet AS568B dimensions and tolerances. For further information contact a Parker O-Ring applications engineer.

2-0xx Sizes: Cross-section $d_2 = 1.78$ mm

Parker No.	Inside diameter mm	Parker No.	Inside diameter mm	Parker No.	Inside diameter mm	Parker No.	Inside diameter mm	Parker No.	Inside diameter mm
2-001*	0.74	2-011	7.65	2-021	23.52	2-031	44.17	2-041	75.92
2-002*	1.07	2-012	9.25	2-022	25.12	2-032	47.35	2-042	82.27
2-003*	1.42	2-013	10.82	2-023	26.70	2-033	50.52	2-043	88.62
2-004	1.78	2-014	12.42	2-024	28.30	2-034	53.70	2-044	94.97
2-005	2.57	2-015	14.00	2-025	29.87	2-035	56.87	2-045	101.32
2-006	2.90	2-016	15.60	2-026	31.47	2-036	60.05	2-046	107.67
2-007	3.68	2-017	17.17	2-027	33.05	2-037	63.22	2-047	114.02
2-008	4.47	2-018	18.77	2-028	34.65	2-038	66.40	2-048	120.37
2-009	5.28	2-019	20.35	2-029	37.82	2-039	69.57	2-049	126.72
2-010	6.07	2-020	21.95	2-030	41.00	2-040	72.75	2-050	133.07

2-1xx Sizes: Cross-section $d_2 = 2.62$ mm

Parker No.	Inside diameter mm	Parker No.	Inside diameter mm	Parker No.	Inside diameter mm	Parker No.	Inside diameter mm	Parker No.	Inside diameter mm
2-102	1.24	2-118	21.89	2-134	47.29	2-150	72.69	2-166	171.12
2-103	2.06	2-119	23.47	2-135	48.90	2-151	75.87	2-167	177.47
2-104	2.84	2-120	25.07	2-136	50.47	2-152	82.22	2-168	183.82
2-105	3.63	2-121	26.64	2-137	52.07	2-153	88.57	2-169	190.17
2-106	4.42	2-122	28.24	2-138	53.64	2-154	94.92	2-170	196.52
2-107	5.23	2-123	29.82	2-139	55.25	2-155	101.27	2-171	202.87
2-108	6.02	2-124	31.42	2-140	56.82	2-156	107.62	2-172	209.22
2-109	7.59	2-125	32.99	2-141	58.42	2-157	113.97	2-173	215.57
2-110	9.19	2-126	34.59	2-142	59.99	2-158	120.32	2-174	221.92
2-111	10.77	2-127	36.17	2-143	61.60	2-159	126.67	2-175	228.27
2-112	12.37	2-128	37.77	2-144	63.17	2-160	133.02	2-176	234.62
2-113	13.94	2-129	39.34	2-145	64.77	2-161	139.37	2-177	240.97
2-114	15.54	2-130	40.94	2-146	66.34	2-162	145.72	2-178	247.32
2-115	17.12	2-131	42.52	2-147	67.95	2-163	152.07		
2-116	18.72	2-132	44.12	2-148	69.52	2-164	158.42		
2-117	20.29	2-133	45.69	2-149	71.12	2-165	164.77		

* Please note: for 2-001 cross-section $d_2 = 1.02$ mm
for 2-002 cross-section $d_2 = 1.27$ mm
for 2-003 cross-section $d_2 = 1.52$ mm

2-2xx Sizes: Cross-section $d_2 = 3.53$ mm

Parker No.	Inside diameter mm	Parker No.	Inside diameter mm	Parker No.	Inside diameter mm	Parker No.	Inside diameter mm	Parker No.	Inside diameter mm
2-201	4.34	2-218	31.34	2-235	78.97	2-252	132.94	2-269	221.84
2-202	5.94	2-219	32.92	2-236	82.14	2-253	136.12	2-270	228.19
2-203	7.52	2-220	34.52	2-237	85.32	2-254	139.29	2-271	234.54
2-204	9.12	2-221	36.09	2-238	88.49	2-255	142.47	2-272	240.89
2-205	10.69	2-222	37.69	2-239	91.67	2-256	145.64	2-273	247.24
2-206	12.29	2-223	40.87	2-240	94.84	2-257	148.52	2-274	253.59
2-207	13.87	2-224	44.04	2-241	98.02	2-258	151.99	2-275	266.29
2-208	15.47	2-225	47.22	2-242	101.19	2-259	158.34	2-276	278.99
2-209	17.04	2-226	50.39	2-243	104.37	2-260	164.69	2-277	291.69
2-210	18.64	2-227	53.57	2-244	107.54	2-261	171.04	2-278	304.39
2-211	20.22	2-228	56.74	2-245	110.72	2-262	177.39	2-279	329.79
2-212	21.82	2-229	59.92	2-246	113.89	2-263	183.74	2-280	355.19
2-213	23.39	2-230	63.09	2-247	117.07	2-264	190.09	2-281	380.59
2-214	24.99	2-231	66.27	2-248	120.24	2-265	196.44	2-282	405.26
2-215	26.57	2-232	69.44	2-249	123.42	2-266	202.79	2-283	430.66
2-216	28.17	2-233	72.62	2-250	126.59	2-267	209.14	2-284	456.06
2-217	29.74	2-234	75.79	2-251	129.77	2-268	215.49		

2-3xx Sizes: Cross-section $d_2 = 5.33$ mm

Parker No.	Inside diameter mm	Parker No.	Inside diameter mm	Parker No.	Inside diameter mm	Parker No.	Inside diameter mm	Parker No.	Inside diameter mm
2-309	10.46	2-327	43.82	2-345	100.97	2-363	164.47	2-381	304.17
2-310	12.07	2-328	46.99	2-346	104.14	2-364	170.82	2-382	329.57
2-311	13.64	2-329	50.17	2-347	107.32	2-365	177.17	2-383	354.97
2-312	15.24	2-330	53.34	2-348	110.49	2-366	183.52	2-384	380.37
2-313	16.81	2-331	56.52	2-349	113.67	2-367	189.87	2-385	405.26
2-314	18.42	2-332	59.69	2-350	116.84	2-368	196.22	2-386	430.66
2-315	19.99	2-333	62.87	2-351	120.02	2-369	202.57	2-387	456.06
2-316	21.59	2-334	66.04	2-352	123.19	2-370	208.92	2-388	481.41
2-317	23.16	2-335	69.22	2-353	126.37	2-371	215.27	2-389	506.81
2-318	24.77	2-336	72.39	2-354	129.54	2-372	221.62	2-390	532.21
2-319	26.34	2-337	75.57	2-355	132.72	2-373	227.97	2-391	557.61
2-320	27.94	2-338	78.74	2-356	135.89	2-374	234.34	2-392	582.68
2-321	29.51	2-339	81.92	2-357	139.07	2-375	240.67	2-393	608.08
2-322	31.12	2-340	85.09	2-358	142.24	2-376	247.02	2-394	633.48
2-323	32.69	2-341	88.27	2-359	145.42	2-377	253.37	2-395	658.88
2-324	34.29	2-342	91.44	2-360	148.59	2-378	266.07		
2-325	37.47	2-343	94.62	2-361	151.77	2-379	278.77		
2-326	40.64	2-344	97.79	2-362	158.12	2-380	291.47		

2-4xx Sizes: Cross-section $d_2 = 6.99$ mm

Parker No.	Inside diameter mm	Parker No.	Inside diameter mm	Parker No.	Inside diameter mm	Parker No.	Inside diameter mm	Parker No.	Inside diameter mm
2-425	113.67	2-436	148.59	2-447	227.97	2-458	367.67	2-469	506.86
2-426	116.84	2-437	151.77	2-448	240.67	2-459	380.37	2-470	532.26
2-427	120.02	2-438	158.12	2-449	253.37	2-460	393.07	2-471	557.66
2-428	123.19	2-439	164.47	2-450	266.07	2-461	405.26	2-472	582.68
2-429	126.37	2-440	170.82	2-451	278.77	2-462	417.96	2-473	608.08
2-430	129.54	2-441	177.17	2-452	291.47	2-463	430.66	2-474	633.48
2-431	132.72	2-442	183.52	2-453	304.17	2-464	443.36	2-475	658.88
2-432	135.89	2-443	189.87	2-454	316.87	2-465	456.06		
2-433	139.07	2-444	196.22	2-455	329.57	2-466	468.76		
2-434	142.24	2-445	202.57	2-456	342.27	2-467	481.46		
2-435	145.42	2-446	215.27	2-457	354.97	2-468	494.16		

The 2-xxx series from Parker Hannifin brings two particular advantages for the user.

- ex-stock in following compounds:

N 674-70 (NBR 70 ShoreA),
 N 552-90 (NBR 90 ShoreA),
 E 540-80 (EPDM 80 ShoreA),
 V 747-75 (FKM 75 ShoreA),

- For each 2-xxx series O-ring we can offer a Parker Parbak® back-up ring to fit. This is particularly important where large clearance gaps and/or high pressures exist (see table page 80).

3-xxx Sizes

Parker No.	Inside diameter mm	Cross section mm	Parker No.	Inside diameter mm	Cross section mm	Parker No.	Inside diameter mm	Cross section mm
3-902	6.07	1.63	3-908	16.36	2.21	3-916	29.74	2.95
3-903	7.65	1.63	3-910	19.18	2.46	3-918	34.42	2.95
3-904	8.92	1.83	3-911	21.92	2.95	3-920	37.47	3.00
3-905	10.52	1.83	3-912	23.47	2.95	3-928	53.09	3.00
3-906	11.89	1.98	3-913	25.04	2.95	3-932	59.36	3.00
3-907	13.46	2.08	3-914	26.59	2.95			

5-xxx Sizes

Parker No.	Inside diameter mm	Cross section mm	Parker No.	Inside diameter mm	Cross section mm	Parker No.	Inside diameter mm	Cross section mm
5-035	45.36	3.53	5-583	6.40	1.90	5-614	9.93	2.62
5-037	51.71	3.53	5-584	7.20	1.90	5-615	11.91	2.62
5-051	1.78	1.02	5-585	8.00	1.88	5-616	13.11	2.62
5-052	6.86	1.78	5-586	8.90	1.90	5-617	15.88	2.62
5-092	701.68	6.99	5-587	8.90	2.70	5-618	25.81	3.53
5-108	4.47	1.27	5-588	10.50	2.70	5-643	16.51	1.14
5-157	33.99	2.34	5-589	12.10	2.70	5-664	8.13	1.78
5-190	3.35	1.78	5-590	13.59	2.69	5-670	36.50	1.78
5-212	9.75	1.78	5-591	15.10	2.70	5-673	7.75	1.88
5-239	14.48	2.69	5-592	16.90	2.70	5-676	15.49	1.47
5-243	15.34	2.62	5-593	18.40	2.70	5-683	3.10	1.60
5-256	17.96	2.62	5-594	18.30	3.60	5-686	6.30	2.39
5-321	39.60	3.53	5-595	19.80	3.60	5-690	17.30	2.40
5-330	42.52	5.33	5-596	21.30	3.60	5-700	9.00	3.00
5-332	42.85	3.53	5-597	23.00	3.60	5-701	49.20	3.53
5-361	67.84	3.53	5-598	24.60	3.60	5-702	58.74	3.53
5-381	88.27	6.99	5-599	26.20	3.60	5-703	65.09	3.53
5-434	180.54	6.99	5-600	27.80	3.60	5-704	71.44	3.53
5-445	210.24	6.99	5-601	29.30	3.60	5-705	74.61	3.53
5-488	316.56	2.62	5-602	30.80	3.60	5-716	9.19	3.00
5-525	425.83	3.18	5-603	32.50	3.60	5-805	64.39	1.78
5-578	2.60	1.90	5-604	34.10	3.60	5-816	80.31	1.78
5-579	3.40	1.90	5-605	35.60	3.60	5-843	118.72	2.62
5-580	4.20	1.90	5-606	37.30	3.60	5-850	125.09	6.60
5-581	4.90	1.90	5-612	8.74	1.78	5-976	264.79	6.60
5-582	5.70	1.90	5-613	11.10	1.78			

6-xxx Sizes

Parker No.	Inside diameter mm	Cross section mm	Parker No.	Inside diameter mm	Cross section mm	Parker No.	Inside diameter mm	Cross section mm
6-001	6.00	2.00	6-048	30.00	2.00	6-102	40.60	4.00
6-002	8.00	2.00	6-049	27.00	2.00	6-103	161.00	3.00
6-003	10.00	2.00	6-050	24.20	3.00	6-104	4.00	2.00
6-005	15.00	2.00	6-051	50.00	2.00	6-105	10.00	2.50
6-006	16.70	1.45	6-052	7.10	1.60	6-106	15.00	2.50
6-007	18.00	3.15	6-053	12.00	1.50	6-107	60.00	4.10
6-008	21.00	2.00	6-054	45.00	2.00	6-108	79.60	3.20
6-009	47.50	4.00	6-055	50.00	2.50	6-109	58.00	4.00
6-010	9.00	1.50	6-056	30.00	3.00	6-110	5.00	2.00
6-011	7.00	1.50	6-058	12.30	2.40	6-112	53.00	6.50
6-012	9.30	2.40	6-059	135.00	3.23	6-113	53.00	5.00
6-013	89.50	3.00	6-060	135.00	3.43	6-114	60.00	5.00
6-015	42.00	1.50	6-061	146.00	3.23	6-115	125.00	8.00
6-016	13.00	2.50	6-063	5.35	1.50	6-116	10.00	1.00
6-017	20.00	2.50	6-065	12.00	2.00	6-118	15.00	1.50
6-018	3.00	1.00	6-066	23.00	2.50	6-119	19.50	1.50
6-019	4.00	1.10	6-067	14.00	2.50	6-120	9.00	1.80
6-020	2.70	1.50	6-069	5.00	1.50	6-121	81.00	3.00
6-021	3.50	1.20	6-070	8.30	2.40	6-122	186.44	6.99
6-022	24.00	2.00	6-072	15.00	3.20	6-123	118.50	3.00
6-023	27.30	2.40	6-074	8.00	1.50	6-124	12.00	3.00
6-025	101.00	3.00	6-075	13.00	2.00	6-125	18.00	4.00
6-026	137.00	3.00	6-076	18.00	2.00	6-126	25.30	1.60
6-027	40.00	2.00	6-078	20.00	1.50	6-128	15.00	5.00
6-028	7.00	2.50	6-079	6.00	5.00	6-129	13.23	1.78
6-030	73.00	3.00	6-080	7.00	3.00	6-130	20.00	3.00
6-031	70.00	3.00	6-082	45.00	1.50	6-132	18.00	2.50
6-032	118.00	2.00	6-083	10.00	1.50	6-133	4.70	1.90
6-033	13.00	1.50	6-084	11.00	1.50	6-134	7.50	2.50
6-034	29.50	1.50	6-085	15.00	1.80	6-135	14.30	2.40
6-035	4.00	1.50	6-086	11.00	2.00	6-136	33.00	2.00
6-036	22.00	2.50	6-087	18.00	1.50	6-137	100.00	5.00
6-037	30.00	3.15	6-088	22.00	1.50	6-138	2.50	1.30
6-038	6.00	1.50	6-089	21.00	3.50	6-139	22.00	2.00
6-039	19.00	2.50	6-090	14.00	2.00	6-140	28.00	2.00
6-040	15.00	1.60	6-091	7.50	1.50	6-141	55.00	2.00
6-041	17.90	1.25	6-092	24.80	1.50	6-142	30.70	2.00
6-042	16.00	3.00	6-095	132.00	3.00	6-143	14.00	1.50
6-043	15.00	3.00	6-096	13.50	2.75	6-146	16.00	2.00
6-044	17.00	2.00	6-097	31.00	4.50	6-147	27.00	3.00
6-045	72.00	3.00	6-099	20.00	1.30	6-148	177.00	2.00
6-046	38.00	2.00	6-100	91.00	3.00	6-149	205.00	2.00
6-047	35.00	2.00	6-101	28.00	1.50	6-150	227.00	2.00

6-xxx Sizes

Parker No.	Inside diameter mm	Cross section mm	Parker No.	Inside diameter mm	Cross section mm	Parker No.	Inside diameter mm	Cross section mm
6-151	63.00	4.00	6-209	398.00	8.00	6-263	22.70	1.50
6-152	210.00	5.00	6-212	20.34	4.25	6-265	619.50	8.00
6-153	320.50	5.33	6-214	4.50	1.50	6-266	693.50	10.10
6-154	36.30	1.78	6-215	425.00	6.00	6-267	734.00	6.99
6-155	48.00	3.00	6-216	90.00	3.00	6-268	827.00	7.00
6-156	30.00	2.50	6-218	10.60	2.00	6-269	950.50	10.06
6-157	98.00	3.00	6-221	38.00	5.00	6-270	1046.00	7.00
6-158	437.00	3.00	6-222	150.00	5.40	6-271	1103.00	10.00
6-159	46.02	3.53	6-223	15.80	2.40	6-272	69.24	3.40
6-160	13.75	2.80	6-224	138.00	6.00	6-273	196.00	12.00
6-161	9.00	2.50	6-226	200.00	6.00	6-274	115.00	3.00
6-162	7.30	2.70	6-227	42.00	3.00	6-275	20.30	2.40
6-163	13.10	1.60	6-228	740.00	10.00	6-276	88.00	3.00
6-164	420.00	5.00	6-229	837.00	10.00	6-277	8.79	1.14
6-165	420.00	3.50	6-230	882.00	10.00	6-278	622.00	8.00
6-166	3.90	1.80	6-232	984.00	10.00	6-279	810.00	7.10
6-167	2.50	1.20	6-233	602.00	8.00	6-280	1016.00	7.00
6-168	2.50	1.70	6-234	283.00	12.00	6-281	241.00	7.00
6-170	159.00	4.00	6-235	637.00	10.00	6-282	171.00	11.00
6-173	422.00	2.00	6-236	689.00	10.00	6-283	330.00	6.00
6-174	100.00	2.50	6-237	786.00	10.00	6-285	21.70	0.73
6-175	273.05	3.53	6-238	285.00	12.00	6-287	22.89	1.00
6-176	577.85	6.99	6-239	1029.00	10.00	6-288	24.32	1.00
6-177	18.30	2.40	6-240	1075.00	10.00	6-289	25.79	1.00
6-178	74.00	2.00	6-241	291.00	6.00	6-290	30.30	2.40
6-179	533.40	3.18	6-242	63.00	2.50	6-291	37.00	2.50
6-180	28.00	2.20	6-243	67.00	1.50	6-292	40.00	3.00
6-183	219.00	5.30	6-245	1154.00	10.00	6-293	47.20	5.70
6-184	83.80	2.62	6-247	624.00	6.99	6-294	74.20	5.70
6-189	25.50	2.00	6-248	783.00	6.99	6-295	19.00	0.80
6-190	840.00	12.00	6-249	910.00	6.99	6-296	27.71	1.02
6-192	8.10	1.60	6-250	936.00	6.99	6-297	16.58	1.50
6-193	44.35	3.00	6-251	3.70	1.90	6-298	23.60	1.02
6-194	49.50	3.00	6-252	231.50	6.00	6-299	191.00	1.78
6-195	79.50	3.00	6-253	106.80	2.66	6-300	19.80	2.40
6-198	12.50	2.00	6-254	218.00	12.00	6-301	677.00	7.00
6-202	514.00	8.00	6-255	126.00	5.00	6-302	955.00	12.60
6-203	367.00	3.50	6-256	480.06	10.00	6-303	763.01	6.99
6-204	381.00	5.00	6-257	93.39	1.47	6-304	887.00	6.99
6-205	39.20	3.00	6-258	17.96	2.62	6-305	736.00	3.53
6-206	15.30	2.40	6-258	17.96	2.62	6-306	2.20	1.60
6-207	13.00	3.50	6-260	506.00	2.62	6-307	3.33	1.02
6-208	26.70	2.50	6-261	504.00	6.99	6-308	18.50	1.50

6-xxx Sizes

Parker No.	Inside diameter mm	Cross section mm	Parker No.	Inside diameter mm	Cross section mm	Parker No.	Inside diameter mm	Cross section mm
6-309	87.30	2.00	6-364	1.98	0.84	6-418	1.85	1.50
6-311	7.00	2.00	6-366	11.89	1.78	6-420	4.00	2.20
6-313	16.50	2.70	6-367	17.81	1.02	6-421	112.00	3.00
6-314	31.02	3.00	6-369	1.50	1.00	6-422	607.00	4.00
6-316	67.00	2.50	6-370	48.00	2.00	6-423	46.87	2.62
6-317	7.80	3.60	6-372	720.00	6.99	6-425	18.00	3.00
6-318	151.70	5.60	6-373	9.53	1.60	6-426	25.00	4.00
6-320	608.00	10.00	6-374	6.30	1.60	6-427	57.00	3.00
6-321	700.00	10.00	6-375	10.25	1.40	6-428	4.00	2.50
6-322	810.00	10.00	6-376	25.00	5.00	6-430	21.20	2.40
6-323	45.00	2.50	6-377	35.00	5.30	6-431	44.00	2.00
6-324	31.00	2.50	6-378	140.00	4.00	6-432	7.50	2.00
6-328	500.00	3.53	6-379	138.00	2.10	6-433	38.00	2.50
6-329	36.00	2.50	6-380	594.51	7.14	6-434	51.50	1.50
6-330	850.00	10.00	6-381	647.70	6.99	6-435	48.40	4.85
6-331	431.80	7.10	6-382	20.20	3.00	6-436	240.00	12.00
6-332	1011.00	5.33	6-385	1071.00	14.40	6-437	8.00	1.00
6-333	1042.00	5.33	6-387	25.80	3.30	6-438	12.00	1.00
6-334	960.00	5.33	6-388	17.40	2.50	6-439	16.00	1.00
6-335	914.00	5.33	6-389	723.90	6.99	6-440	6.80	2.00
6-336	262.00	5.33	6-390	8.00	3.00	6-441	3.00	1.50
6-337	41.40	2.62	6-392	99.00	6.99	6-442	25.00	2.00
6-338	5.60	2.40	6-393	1060.00	10.00	6-443	24.00	6.00
6-339	94.50	3.00	6-394	514.00	8.00	6-444	159.20	5.70
6-340	14.60	2.40	6-395	9.35	1.60	6-445	82.00	4.00
6-341	137.30	8.00	6-396	18.20	3.00	6-446	94.00	2.00
6-342	204.00	8.00	6-397	14.50	1.60	6-447	58.00	2.00
6-343	21.50	1.78	6-399	94.50	3.00	6-448	119.20	5.70
6-344	6.20	1.50	6-400	27.00	1.50	6-449	41.00	3.00
6-345	8.20	1.50	6-401	4.50	1.00	6-451	129.20	5.70
6-346	9.40	2.10	6-402	3.50	1.25	6-452	85.20	9.25
6-347	11.40	2.10	6-404	19.00	5.00	6-453	24.00	4.00
6-348	13.40	2.10	6-405	93.50	9.50	6-454	30.00	4.00
6-349	15.40	2.10	6-407	242.00	6.00	6-455	62.00	2.50
6-350	19.40	2.10	6-408	0.80	1.60	6-456	84.00	3.00
6-351	23.70	2.80	6-409	940.00	10.00	6-457	125.00	5.00
6-352	29.70	2.80	6-411	60.00	2.50	6-458	400.00	12.00
6-353	38.70	2.80	6-412	238.00	5.00	6-459	37.36	2.60
6-354	46.70	2.80	6-413	100.00	4.00	6-460	996.00	7.00
6-356	22.10	1.60	6-414	41.75	2.60	6-461	213.68	7.14
6-360	19.00	2.00	6-415	800.00	5.33	6-462	558.00	10.00
6-361	3.30	2.40	6-416	65.00	5.30	6-464	76.00	4.50
6-363	865.00	12.00	6-417	760.00	5.00	6-466	188.00	4.00

6-xxx Sizes

Parker No.	Inside diameter mm	Cross section mm	Parker No.	Inside diameter mm	Cross section mm	Parker No.	Inside diameter mm	Cross section mm
6-467	528.00	8.00	6-520	8.00	2.20	6-569	80.00	2.00
6-468	3.50	1.50	6-521	716.00	8.00	6-570	215.00	6.00
6-469	330.00	8.00	6-523	65.00	3.00	6-571	10.15	1.40
6-470	9.00	2.00	6-524	17.00	1.10	6-572	6.50	2.00
6-471	11.30	2.40	6-525	41.28	3.53	6-573	19.00	1.50
6-472	33.30	2.40	6-527	974.00	7.00	6-574	86.84	5.33
6-473	13.60	2.50	6-528	16.00	1.50	6-575	39.00	2.00
6-474	63.00	4.50	6-529	524.00	10.00	6-576	160.00	3.00
6-475	10.30	2.40	6-530	455.00	8.00	6-577	130.00	6.00
6-476	17.00	1.50	6-531	710.00	5.33	6-578	445.00	8.00
6-480	6.60	1.50	6-532	10.00	2.20	6-579	87.00	3.00
6-483	74.00	3.00	6-534	1004.00	8.00	6-580	118.31	3.53
6-485	225.00	5.00	6-535	680.00	5.00	6-581	6.50	1.50
6-486	7.80	4.60	6-536	635.00	5.00	6-582	95.50	3.53
6-487	2.90	1.02	6-538	2.40	1.90	6-583	5.00	1.20
6-489	21.00	6.00	6-539	70.00	4.50	6-584	13.00	1.00
6-491	3.50	1.10	6-540	33.00	2.50	6-585	34.40	3.10
6-492	174.00	3.00	6-541	41.00	2.50	6-586	39.40	3.10
6-493	22.00	1.39	6-542	44.20	2.50	6-587	74.40	3.10
6-494	162.50	3.53	6-543	6.00	1.00	6-588	84.40	3.10
6-495	190.00	3.00	6-544	24.00	1.50	6-589	105.00	2.00
6-496	151.00	3.00	6-545	35.00	4.50	6-592	8.00	1.25
6-497	27.50	1.50	6-546	205.00	3.00	6-593	19.20	3.00
6-497	27.50	1.50	6-547	197.00	3.00	6-594	42.00	2.50
6-498	90.00	2.00	6-548	5.70	3.20	6-595	24.00	2.50
6-499	18.60	2.00	6-549	3.00	1.20	6-596	65.00	4.50
6-500	66.00	2.00	6-550	12.50	1.10	6-597	875.00	8.00
6-501	65.00	2.00	6-551	10.80	1.50	6-598	375.00	5.34
6-502	220.00	3.00	6-552	70.00	2.00	6-600	209.20	5.70
6-503	19.30	2.40	6-553	304.80	1.78	6-601	100.00	2.00
6-504	120.00	3.00	6-554	17.40	2.10	6-602	140.00	10.00
6-505	270.00	3.00	6-555	37.00	5.00	6-603	50.00	4.00
6-508	849.00	7.00	6-556	52.00	3.00	6-604	240.00	3.00
6-509	819.00	7.00	6-556	52.00	3.00	6-605	10.00	3.00
6-510	315.00	6.00	6-557	18.60	3.50	6-606	35.00	2.50
6-511	140.00	3.00	6-558	87.20	2.50	6-607	315.00	4.00
6-512	144.00	3.70	6-559	137.00	14.00	6-608	94.20	5.70
6-513	82.00	2.00	6-560	59.70	7.00	6-609	36.00	2.20
6-514	250.00	3.00	6-561	88.30	7.00	6-610	9.00	1.20
6-515	134.00	3.00	6-562	16.00	2.50	6-611	25.00	1.50
6-516	230.00	3.00	6-564	8.00	2.50	6-612	125.00	3.00
6-517	335.00	3.00	6-566	40.00	2.50	6-613	4.00	1.00
6-518	355.00	3.00	6-568	56.00	2.00	6-614	190.00	5.00

6-xxx Sizes

Parker No.	Inside diameter mm	Cross section mm	Parker No.	Inside diameter mm	Cross section mm	Parker No.	Inside diameter mm	Cross section mm
6-615	3.00	2.00	6-667	770.00	10.00	6-719	57.00	2.50
6-618	234.32	1.78	6-668	708.00	10.00	6-720	93.00	2.00
6-619	20.00	2.00	6-669	450.00	10.00	6-722	128.00	2.00
6-621	535.46	7.24	6-670	550.00	10.00	6-723	380.00	4.00
6-622	34.00	2.80	6-671	245.00	10.00	6-724	102.00	3.00
6-623	149.20	5.70	6-672	364.00	10.00	6-725	16.56	1.78
6-626	580.00	8.00	6-673	48.20	1.78	6-726	45.00	5.00
6-627	10.10	1.00	6-674	120.00	1.50	6-728	26.00	1.00
6-628	19.30	3.65	6-676	84.00	2.50	6-729	78.00	3.00
6-630	51.00	3.00	6-677	11.50	1.00	6-730	13.00	3.00
6-631	179.00	3.00	6-678	36.00	2.00	6-731	18.00	1.30
6-632	16.00	1.25	6-682	375.00	10.00	6-733	85.00	2.00
6-633	61.00	4.50	6-683	15.00	1.00	6-734	430.00	12.00
6-634	71.00	4.50	6-684	3.20	1.02	6-736	3.17	1.02
6-635	236.00	7.00	6-685	3.40	2.00	6-737	13.89	1.30
6-636	64.00	3.00	6-686	3.20	1.60	6-738	5.33	1.02
6-638	281.00	5.00	6-687	21.50	1.50	6-740	109.00	3.00
6-640	97.00	1.50	6-688	133.35	5.33	6-741	428.00	5.70
6-642	40.00	1.50	6-689	150.00	3.00	6-742	614.00	7.00
6-643	57.00	1.50	6-690	546.00	7.00	6-743	93.00	3.00
6-644	638.89	5.44	6-692	8.50	1.50	6-745	25.30	2.40
6-645	665.00	5.00	6-693	130.00	2.50	6-745	25.30	2.40
6-646	32.00	2.70	6-694	36.00	2.10	6-746	169.20	5.70
6-647	617.00	7.00	6-698	140.00	2.00	6-747	196.00	4.00
6-648	820.00	7.00	6-699	62.00	3.00	6-748	5.70	1.05
6-649	798.00	7.00	6-700	96.00	2.00	6-749	26.00	2.50
6-650	853.00	7.00	6-701	695.00	6.99	6-750	45.90	1.50
6-651	9.00	4.00	6-702	707.00	6.99	6-751	5.30	2.40
6-652	6.00	5.20	6-703	55.30	2.00	6-752	34.65	2.60
6-653	664.00	5.00	6-704	180.00	3.00	6-753	39.50	2.60
6-654	28.00	2.50	6-705	14.00	3.00	6-754	76.00	2.50
6-655	174.20	5.70	6-706	189.20	5.70	6-755	18.00	5.00
6-656	26.00	2.00	6-707	865.00	8.40	6-756	148.00	10.00
6-657	7.00	1.00	6-708	929.00	6.00	6-757	73.00	4.00
6-658	8.00	1.40	6-709	565.00	7.00	6-758	19.75	2.50
6-659	67.00	3.00	6-710	7.50	1.00	6-759	43.25	2.60
6-660	27.00	5.00	6-711	388.00	5.00	6-760	31.95	2.60
6-661	7.50	1.25	6-713	6.00	1.25	6-762	107.31	6.99
6-662	12.00	3.80	6-714	1.80	1.00	6-763	89.60	5.70
6-663	30.00	4.65	6-715	8.80	1.00	6-764	59.60	5.85
6-664	54.00	4.65	6-716	320.00	6.00	6-766	31.70	3.50
6-665	60.00	3.00	6-717	11.00	2.50	6-767	109.40	3.10
6-666	24.00	1.00	6-718	258.40	1.60	6-768	119.60	5.70

6-xxx Sizes

Parker No.	Inside diameter mm	Cross section mm	Parker No.	Inside diameter mm	Cross section mm	Parker No.	Inside diameter mm	Cross section mm
6-769	114.40	3.10	6-819	54.00	3.00	6-868	195.00	3.50
6-772	44.70	3.50	6-820	79.00	1.50	6-869	32.00	2.00
6-773	155.00	10.00	6-821	83.00	1.00	6-871	260.00	5.00
6-774	12.00	2.50	6-822	85.00	1.50	6-872	150.00	4.00
6-775	515.00	10.00	6-823	10.00	2.65	6-873	112.00	4.00
6-777	10.60	1.80	6-824	69.00	3.00	6-874	95.00	5.00
6-778	53.00	1.80	6-825	27.00	3.20	6-875	41.60	2.40
6-779	19.00	2.65	6-826	78.00	3.50	6-876	16.50	1.00
6-780	21.20	2.65	6-827	470.00	10.00	6-877	22.00	4.00
6-781	28.00	2.65	6-831	590.00	3.50	6-878	245.00	3.00
6-782	38.70	2.65	6-832	96.00	9.00	6-879	54.00	4.00
6-783	45.00	2.65	6-833	137.00	4.00	6-880	2.30	1.30
6-784	32.50	3.55	6-834	484.86	3.53	6-881	37.00	3.00
6-785	56.00	3.55	6-835	449.50	6.99	6-882	45.00	1.00
6-786	67.00	3.55	6-836	543.50	6.99	6-883	60.00	1.20
6-787	71.00	3.55	6-837	109.20	5.70	6-884	68.00	3.00
6-788	80.00	3.55	6-838	32.00	4.00	6-885	80.50	4.00
6-790	80.00	1.80	6-839	10.10	1.78	6-887	172.00	3.00
6-791	50.00	4.50	6-839	10.10	1.78	6-889	174.30	3.50
6-792	61.00	5.00	6-840	282.37	3.53	6-890	870.00	8.00
6-793	20.00	1.80	6-841	175.00	10.00	6-891	16.00	2.65
6-794	28.00	1.80	6-842	255.00	4.00	6-892	400.00	5.00
6-797	2.00	1.00	6-844	135.00	4.00	6-893	52.20	5.70
6-798	19.00	1.80	6-845	42.50	1.80	6-894	27.00	2.50
6-799	468.00	6.00	6-845	42.50	1.80	6-895	359.20	13.80
6-800	500.00	8.00	6-846	234.20	7.00	6-896	257.20	14.00
6-801	21.20	3.55	6-848	18.14	1.78	6-897	380.00	6.00
6-802	33.50	2.65	6-849	4.80	0.75	6-898	429.00	6.00
6-803	30.00	3.55	6-850	32.00	2.50	6-899	70.00	5.00
6-804	92.50	3.55	6-851	61.00	2.00	6-900	83.00	3.00
6-805	77.00	2.00	6-852	64.39	1.78	6-902	130.00	5.00
6-806	105.00	3.50	6-853	85.00	4.00	6-903	110.00	3.00
6-807	370.00	5.50	6-854	298.00	2.62	6-904	13.00	1.30
6-808	20.00	3.55	6-855	6.30	1.80	6-905	28.00	1.00
6-809	43.70	1.80	6-856	7.50	1.80	6-906	1.00	1.00
6-810	54.50	2.65	6-857	16.00	1.80	6-907	6.80	1.80
6-812	133.50	12.00	6-861	5.80	0.75	6-909	449.00	12.00
6-813	341.00	14.00	6-862	180.00	10.00	6-910	10.00	2.62
6-814	164.20	5.84	6-863	95.00	4.00	6-911	165.00	2.00
6-815	109.20	5.84	6-864	238.00	4.00	6-912	49.20	3.00
6-816	670.00	10.00	6-865	201.00	4.00	6-913	27.20	3.00
6-817	590.00	10.00	6-866	9.30	1.50	6-914	34.00	3.00
6-818	160.00	4.00	6-867	89.20	5.70	6-915	110.00	5.00

6-xxx Sizes

Parker No.	Inside diameter mm	Cross section mm	Parker No.	Inside diameter mm	Cross section mm	Parker No.	Inside diameter mm	Cross section mm
6-916	25.00	2.50	6-960	5.61	1.68	6-1006	102.00	6.00
6-917	296.00	6.00	6-961	122.00	3.00	6-1007	187.10	8.40
6-918	234.10	8.40	6-962	151.00	4.00	6-1008	463.00	7.00
6-919	515.90	6.00	6-963	93.00	4.00	6-1010	249.30	5.70
6-920	195.50	12.00	6-964	50.00	3.00	6-1012	84.30	5.70
6-921	76.00	3.00	6-965	10.40	1.00	6-1013	72.00	4.00
6-922	7.00	1.40	6-966	2.50	1.00	6-1014	85.00	3.00
6-923	36.00	3.00	6-967	245.00	10.85	6-1015	132.00	4.00
6-924	900.00	10.00	6-968	5.50	1.50	6-1016	87.20	5.70
6-925	2.06	0.66	6-969	25.00	3.00	6-1017	613.92	6.99
6-927	380.00	8.00	6-970	37.00	1.50	6-1018	289.42	5.87
6-928	11.50	1.50	6-972	40.82	2.59	6-1019	2.35	1.00
6-929	13.30	2.40	6-973	3.50	0.80	6-1020	46.00	3.00
6-930	477.00	10.50	6-974	17.00	3.50	6-1021	16.00	4.00
6-931	10.00	6.50	6-975	44.83	2.67	6-1022	6.75	1.78
6-932	150.00	2.00	6-976	10.50	1.50	6-1023	40.00	5.00
6-933	6.40	1.30	6-977	28.00	3.00	6-1024	53.00	3.50
6-934	401.71	3.53	6-978	78.00	2.50	6-1025	38.00	3.50
6-935	307.57	3.53	6-979	72.00	2.50	6-1026	5.00	1.00
6-936	272.64	3.53	6-980	36.00	1.50	6-1027	24.00	3.00
6-937	7.00	2.35	6-981	36.00	2.00	6-1028	185.00	5.00
6-938	409.00	6.99	6-982	114.00	3.00	6-1029	94.00	4.00
6-939	434.00	6.99	6-983	164.20	5.70	6-1030	248.00	5.00
6-940	15.30	2.20	6-984	2965.00	7.00	6-1031	28.00	5.00
6-941	68.00	5.00	6-985	56.00	3.00	6-1032	7.70	2.00
6-942	23.60	2.90	6-986	635.00	9.00	6-1033	2.80	1.60
6-943	748.50	7.00	6-988	270.00	5.33	6-1034	61.00	4.00
6-944	46.00	4.00	6-990	69.00	2.50	6-1035	5.00	2.50
6-945	11.50	2.50	6-991	86.00	2.62	6-1036	4.60	2.00
6-946	17.00	3.00	6-992	79.30	2.62	6-1037	65.00	5.00
6-947	325.00	5.33	6-993	35.00	3.20	6-1038	39.00	3.00
6-948	274.00	5.33	6-994	4.00	3.00	6-1039	16.30	2.40
6-949	223.00	5.33	6-995	105.00	4.00	6-1039	16.30	2.40
6-950	5.50	2.00	6-996	43.00	3.00	6-1040	18.00	2.20
6-951	526.00	6.99	6-997	45.00	3.00	6-1041	47.00	2.50
6-952	9.50	1.00	6-998	19.00	3.00	6-1042	261.00	6.00
6-953	11.00	3.00	6-999	23.00	2.00	6-1043	338.00	6.00
6-954	214.63	2.18	6-1000	29.00	3.00	6-1044	190.00	4.00
6-955	5.00	1.75	6-1001	75.00	4.00	6-1045	162.00	2.50
6-956	7.10	2.00	6-1002	78.00	5.00	6-1046	145.00	5.00
6-957	25.60	1.93	6-1003	120.00	6.00	6-1047	34.00	1.00
6-958	20.00	4.00	6-1004	172.00	6.00	6-1048	218.00	5.80
6-959	7.00	1.20	6-1005	114.20	5.70	6-1049	14.00	1.10

6-xxx Sizes

Parker No.	Inside diameter mm	Cross section mm	Parker No.	Inside diameter mm	Cross section mm	Parker No.	Inside diameter mm	Cross section mm
6-1050	218.00	6.00	6-1093	142.00	6.00	6-1136	140.00	5.00
6-1051	142.00	4.00	6-1094	63.00	6.00	6-1137	57.00	4.00
6-1052	88.00	4.00	6-1095	94.00	3.00	6-1138	33.00	3.00
6-1053	65.00	4.00	6-1096	129.00	4.00	6-1139	200.00	5.00
6-1054	44.00	3.00	6-1097	170.00	4.00	6-1140	36.00	3.00
6-1055	103.00	5.00	6-1098	179.20	5.70	6-1141	47.00	2.00
6-1056	93.00	5.00	6-1099	15.00	4.00	6-1142	360.00	4.00
6-1057	80.00	4.00	6-1100	35.00	1.50	6-1143	124.00	4.00
6-1058	185.00	3.00	6-1101	360.00	7.50	6-1144	41.00	1.50
6-1059	47.00	4.00	6-1102	5.69	1.14	6-1145	56.00	4.00
6-1060	43.00	4.00	6-1103	90.00	7.00	6-1146	31.50	3.15
6-1061	92.00	4.00	6-1104	62.00	4.00	6-1147	150.00	6.00
6-1062	95.00	4.50	6-1105	116.50	1.78	6-1148	39.40	2.10
6-1063	220.00	5.00	6-1106	108.00	8.00	6-1149	6.50	1.20
6-1064	22.20	3.00	6-1107	152.00	8.00	6-1150	34.40	2.10
6-1065	55.00	3.00	6-1108	180.52	5.33	6-1151	115.00	2.00
6-1066	1960.00	10.85	6-1109	17.20	3.00	6-1152	79.20	5.70
6-1067	2072.00	10.00	6-1110	180.00	6.00	6-1153	206.00	7.00
6-1068	175.00	6.00	6-1111	88.00	8.00	6-1154	136.00	4.00
6-1069	77.10	2.62	6-1112	23.00	3.00	6-1155	245.00	5.00
6-1070	49.20	5.70	6-1113	90.00	2.50	6-1156	890.00	5.00
6-1071	755.00	5.00	6-1114	40.00	6.00	6-1157	615.00	5.00
6-1072	465.00	5.00	6-1115	22.00	1.30	6-1158	520.00	5.00
6-1073	128.00	5.00	6-1116	35.00	3.00	6-1159	115.00	5.00
6-1074	105.00	5.00	6-1117	62.00	6.00	6-1160	695.00	5.00
6-1075	75.00	3.00	6-1118	210.00	4.00	6-1161	160.00	5.00
6-1076	120.00	4.00	6-1119	180.00	8.00	6-1162	63.00	3.50
6-1077	81.00	4.00	6-1120	3.00	2.70	6-1163	102.00	4.00
6-1078	23.00	1.50	6-1121	185.00	6.00	6-1164	114.00	5.00
6-1079	750.00	5.00	6-1122	9.00	3.00	6-1165	88.00	6.00
6-1080	485.00	5.00	6-1123	64.20	5.70	6-1166	35.00	4.00
6-1081	160.00	5.00	6-1124	35.15	3.15	6-1167	248.00	7.00
6-1082	26.00	3.00	6-1125	311.00	10.00	6-1168	300.00	6.00
6-1083	22.00	3.00	6-1126	329.00	10.00	6-1169	115.00	5.00
6-1084	130.00	4.00	6-1127	580.50	3.53	6-1170	515.00	5.00
6-1085	135.00	5.00	6-1128	460.00	5.34	6-1171	315.00	5.00
6-1086	22.30	2.40	6-1129	335.00	7.00	6-1172	320.62	3.53
6-1087	36.20	3.00	6-1130	840.50	7.00	6-1173	764.00	6.99
6-1088	180.00	4.00	6-1131	835.50	7.00	6-1174	85.00	6.00
6-1089	99.20	5.70	6-1132	250.00	8.00	6-1175	104.50	3.00
6-1090	336.00	7.00	6-1133	9.52	1.78	6-1176	46.00	2.00
6-1091	20.00	5.00	6-1134	84.00	3.50	6-1177	172.00	4.00
6-1092	38.00	3.00	6-1135	345.00	5.00	6-1178	45.00	4.00

6-xxx Sizes

Parker No.	Inside diameter mm	Cross section mm	Parker No.	Inside diameter mm	Cross section mm	Parker No.	Inside diameter mm	Cross section mm
6-1179	90.00	4.00	6-1221	500.00	5.00	6-1264	2.20	1.00
6-1180	120.00	5.00	6-1222	770.00	7.00	6-1265	90.00	4.80
6-1181	80.00	5.00	6-1223	860.00	3.00	6-1266	7.30	2.40
6-1182	112.00	7.00	6-1224	42.00	5.00	6-1267	40.00	5.00
6-1183	7.50	2.10	6-1225	222.00	7.00	6-1268	6.30	2.40
6-1184	54.00	2.00	6-1226	50.00	5.00	6-1269	1.50	0.60
6-1185	52.50	1.80	6-1227	252.00	4.00	6-1270	80.00	3.00
6-1186	55.00	4.00	6-1228	8.50	2.00	6-1271	56.70	3.00
6-1187	37.00	3.00	6-1229	564.30	6.99	6-1272	68.00	4.00
6-1188	37.00	2.00	6-1230	10.80	1.90	6-1273	66.00	5.00
6-1189	43.00	2.00	6-1231	260.00	4.00	6-1274	54.00	2.00
6-1190	266.00	4.00	6-1232	26.00	1.50	6-1275	11.60	2.20
6-1191	290.00	5.00	6-1233	145.00	4.00	6-1276	19.00	1.00
6-1192	55.00	3.50	6-1234	52.00	2.50	6-1277	135.00	3.00
6-1193	66.00	3.00	6-1235	336.00	5.33	6-1278	299.50	5.00
6-1194	70.00	4.00	6-1236	11.00	1.00	6-1279	273.60	5.00
6-1195	45.00	4.50	6-1237	100.00	8.00	6-1280	180.00	5.00
6-1196	48.00	4.00	6-1238	194.00	14.00	6-1281	125.00	2.50
6-1196	48.00	4.00	6-1239	238.00	14.00	6-1282	238.00	10.00
6-1197	34.00	2.00	6-1240	285.00	14.10	6-1283	195.00	5.00
6-1198	13.30	1.20	6-1241	385.00	14.20	6-1284	240.00	8.00
6-1199	125.00	4.00	6-1242	415.00	14.20	6-1285	49.20	3.53
6-1200	104.00	5.30	6-1243	480.00	14.00	6-1286	8.65	2.80
6-1201	260.00	8.00	6-1244	585.00	14.00	6-1287	4.00	1.80
6-1202	13.30	3.00	6-1245	735.00	15.00	6-1288	14.00	1.00
6-1203	30.00	2.15	6-1246	853.00	20.00	6-1289	24.50	3.15
6-1204	24.69	1.78	6-1247	1.53	0.97	6-1290	170.00	5.00
6-1205	362.00	5.00	6-1248	46.00	5.00	6-1291	4.50	2.25
6-1206	9.50	2.50	6-1249	7.30	3.40	6-1292	160.00	6.00
6-1207	142.00	12.00	6-1250	225.00	3.00	6-1293	230.00	8.00
6-1208	10.90	1.20	6-1251	6.36	0.72	6-1294	155.00	3.00
6-1209	62.00	3.53	6-1252	21.00	4.00	6-1295	150.00	5.00
6-1210	320.00	3.00	6-1253	49.00	2.00	6-1296	130.00	3.00
6-1211	228.00	3.00	6-1254	368.00	6.00	6-1297	9.50	2.00
6-1212	70.00	8.00	6-1255	343.00	6.00	6-1298	17.86	2.62
6-1213	1005.00	15.00	6-1256	440.00	4.00	6-1299	540.00	5.00
6-1214	90.00	5.00	6-1257	37.50	4.00	6-1300	579.00	5.00
6-1215	780.00	7.00	6-1258	330.00	5.00	6-1301	602.00	5.00
6-1216	10.00	1.60	6-1259	26.00	4.00	6-1302	216.00	4.00
6-1217	131.50	4.00	6-1260	192.00	4.00	6-1303	99.00	3.00
6-1218	340.00	4.00	6-1261	62.00	4.00	6-1304	1840.00	5.00
6-1219	480.00	4.00	6-1262	632.00	6.00	6-1305	100.00	3.00
6-1220	610.00	4.00	6-1263	246.00	4.00	6-1306	97.00	5.00

6-xxx Sizes

Parker No.	Inside diameter mm	Cross section mm	Parker No.	Inside diameter mm	Cross section mm	Parker No.	Inside diameter mm	Cross section mm
6-1307	200.00	4.00	6-1354	58.00	3.00	6-1401	31.00	2.00
6-1308	640.00	6.00	6-1356	175.00	5.00	6-1402	165.00	4.00
6-1309	740.00	6.00	6-1357	75.00	2.50	6-1403	265.00	5.00
6-1310	300.00	10.00	6-1358	0.90	0.53	6-1404	325.00	5.00
6-1311	21.00	3.00	6-1359	304.80	3.18	6-1405	4.05	1.77
6-1312	6.00	1.52	6-1360	236.00	6.00	6-1406	85.00	6.99
6-1313	11.50	2.00	6-1361	12.10	1.60	6-1407	9.50	1.80
6-1314	9.50	1.78	6-1362	39.20	5.70	6-1408	331.50	6.00
6-1315	22.00	2.10	6-1363	3.90	2.40	6-1409	534.00	8.00
6-1316	80.00	3.50	6-1364	17.50	4.00	6-1410	1.00	0.63
6-1317	53.80	4.00	6-1365	17.00	4.00	6-1411	33.00	3.50
6-1318	155.00	4.00	6-1366	30.00	5.00	6-1412	38.00	5.00
6-1319	42.00	4.00	6-1367	110.00	2.50	6-1413	43.00	5.50
6-1320	107.00	8.00	6-1368	60.00	4.50	6-1414	35.00	5.00
6-1321	7.10	3.60	6-1369	76.00	2.00	6-1415	97.00	4.00
6-1322	116.00	3.00	6-1370	300.00	8.00	6-1416	8.10	2.00
6-1323	11.60	1.20	6-1371	310.00	5.00	6-1417	77.00	2.50
6-1324	155.00	5.00	6-1372	65.00	1.80	6-1418	661.00	14.00
6-1325	1865.00	5.00	6-1373	20.00	2.65	6-1419	62.00	1.50
6-1326	410.00	6.00	6-1374	395.00	12.00	6-1420	500.00	6.00
6-1327	6.00	2.50	6-1375	21.20	1.80	6-1421	115.00	6.00
6-1328	383.60	5.00	6-1376	11.20	1.80	6-1422	7.65	2.00
6-1329	134.00	8.00	6-1377	65.00	2.65	6-1422	7.65	2.00
6-1330	12.00	10.60	6-1378	28.20	1.00	6-1423	29.00	2.50
6-1333	51.94	3.53	6-1379	12.50	1.80	6-1424	297.00	4.00
6-1334	340.00	10.00	6-1380	68.00	3.50	6-1425	220.00	7.00
6-1335	412.00	8.00	6-1381	105.00	3.00	6-1426	238.00	6.00
6-1336	167.50	3.50	6-1384	240.66	7.40	6-1427	120.00	10.00
6-1337	11.10	1.82	6-1385	5.60	1.80	6-1428	185.00	4.00
6-1338	23.80	2.40	6-1386	11.00	3.40	6-1429	91.00	2.00
6-1339	13.70	2.50	6-1387	390.00	4.00	6-1430	19.35	1.00
6-1340	15.50	2.60	6-1388	256.00	4.00	6-1431	23.00	4.00
6-1341	17.20	1.82	6-1389	38.00	1.50	6-1432	16.00	6.00
6-1342	14.00	1.82	6-1390	155.00	3.53	6-1433	23.00	6.00
6-1345	14.00	1.60	6-1391	192.00	8.00	6-1434	5.00	1.60
6-1346	240.00	5.00	6-1392	354.96	6.09	6-1435	440.00	4.30
6-1347	53.00	2.00	6-1393	14.70	3.50	6-1436	131.00	5.30
6-1348	73.00	7.00	6-1394	5.15	1.80	6-1437	50.00	3.50
6-1349	44.30	5.70	6-1395	100.00	6.00	6-1438	54.70	3.53
6-1350	104.30	5.70	6-1396	15.08	2.62	6-1439	61.70	4.50
6-1351	309.30	5.70	6-1398	15.00	3.50	6-1440	9.55	1.75
6-1352	419.30	5.70	6-1399	42.00	4.50	6-1443	675.00	5.30
6-1353	21.00	1.00	6-1400	7.00	2.75	6-1444	490.00	5.00

6-xxx Sizes

Parker No.	Inside diameter mm	Cross section mm	Parker No.	Inside diameter mm	Cross section mm	Parker No.	Inside diameter mm	Cross section mm
6-1445	85.00	5.00	6-1489	50.20	3.00	6-1533	28.00	4.00
6-1446	21.30	2.30	6-1490	20.50	3.00	6-1534	245.00	7.00
6-1447	27.00	2.70	6-1491	10.10	1.60	6-1536	11.30	2.20
6-1448	55.00	5.00	6-1492	11.30	1.50	6-1537	14.20	1.90
6-1449	10.00	8.00	6-1493	16.50	2.00	6-1538	7.60	1.90
6-1450	198.00	4.00	6-1494	15.70	2.50	6-1539	8.55	1.75
6-1451	235.00	4.00	6-1495	1.45	1.75	6-1540	27.50	2.00
6-1452	92.00	3.00	6-1496	3.90	1.80	6-1541	15.50	1.50
6-1453	195.00	6.00	6-1497	40.00	4.00	6-1542	9.50	1.50
6-1454	11.50	2.30	6-1498	11.50	1.80	6-1543	18.80	1.90
6-1456	24.60	3.40	6-1499	9.60	2.00	6-1545	24.50	1.00
6-1457	86.00	4.00	6-1499	9.60	2.00	6-1546	328.00	6.99
6-1458	320.00	6.50	6-1500	7.52	3.51	6-1548	15.10	2.60
6-1460	10.20	1.50	6-1501	5.46	0.89	6-1549	18.20	2.60
6-1461	31.57	1.98	6-1502	9.78	1.27	6-1550	22.20	3.10
6-1462	70.00	2.50	6-1503	12.83	1.27	6-1551	28.30	3.10
6-1463	19.50	3.50	6-1504	13.59	2.69	6-1552	54.40	4.25
6-1464	14.50	3.00	6-1505	10.78	2.62	6-1553	152.00	1.78
6-1465	20.50	2.00	6-1506	1.42	1.58	6-1553	152.00	1.78
6-1466	12.00	1.30	6-1507	92.20	2.62	6-1554	70.00	3.50
6-1467	77.50	2.62	6-1508	88.50	6.50	6-1555	14.00	2.20
6-1468	11.75	1.55	6-1509	118.00	4.00	6-1556	32.00	1.50
6-1469	12.00	1.40	6-1510	11.10	2.15	6-1558	7.00	1.47
6-1470	21.00	1.50	6-1511	9.50	2.15	6-1559	136.00	3.00
6-1471	6.00	1.80	6-1512	32.00	1.50	6-1560	221.00	1.78
6-1472	82.00	3.00	6-1513	54.00	1.50	6-1562	8.00	1.60
6-1473	128.00	3.00	6-1515	119.60	3.20	6-1563	198.00	8.00
6-1474	30.00	2.25	6-1516	11.00	1.60	6-1564	240.00	8.00
6-1475	78.00	2.00	6-1517	29.10	1.60	6-1565	205.00	5.00
6-1476	275.00	5.00	6-1518	10.00	1.20	6-1566	12.00	1.20
6-1477	285.00	5.00	6-1519	7.50	1.50	6-1567	12.50	1.50
6-1478	31.00	1.50	6-1520	44.35	2.58	6-1568	3.80	1.90
6-1479	3.15	1.50	6-1521	450.00	2.62	6-1569	17.30	2.20
6-1480	17.70	1.78	6-1522	255.00	5.00	6-1570	7.50	3.00
6-1481	8.56	1.07	6-1523	7.10	1.37	6-1571	13.50	1.50
6-1482	39.00	5.00	6-1524	16.30	1.40	6-1572	126.00	5.10
6-1483	47.00	5.50	6-1525	11.10	1.60	6-1573	86.50	4.00
6-1484	13.00	1.58	6-1526	13.00	1.30	6-1575	11.50	1.78
6-1485	11.80	2.65	6-1528	621.00	8.50	6-1576	14.00	1.30
6-1486	42.00	1.00	6-1529	165.00	5.00	6-1577	736.60	5.00
6-1487	9.20	2.70	6-1530	9.10	1.60	6-1578	31.00	4.00
6-1488	5.00	1.90	6-1531	9.10	1.65	6-1579	16.50	1.50
6-1488	5.00	1.90	6-1532	3.50	1.35	6-1580	110.00	1.50

6-xxx Sizes

Parker No.	Inside diameter mm	Cross section mm	Parker No.	Inside diameter mm	Cross section mm	Parker No.	Inside diameter mm	Cross section mm
6-1581	6.07	1.30	6-1614	33.00	5.00	6-1646	190.00	10.00
6-1582	250.00	10.00	6-1615	0.83	1.63	6-1648	10.00	1.25
6-1583	350.00	10.00	6-1625	154.60	1.78	6-1650	35.50	4.00
6-1584	430.00	16.00	6-1627	30.00	1.00	6-1651	112.00	2.50
6-1585	59.20	5.70	6-1628	73.00	2.00	6-1652	36.00	5.00
6-1586	18.00	10.00	6-1629	88.00	5.00	6-1654	224.00	6.00
6-1587	52.00	1.00	6-1630	122.00	6.00	6-1655	26.50	4.00
6-1588	65.00	1.00	6-1631	34.00	2.50	6-1656	9.86	1.78
6-1589	38.00	1.00	6-1632	145.00	2.50	6-1657	53.50	2.00
6-1590	21.50	1.00	6-1633	47.00	3.00	6-1658	14.40	2.00
6-1591	129.00	1.50	6-1634	32.50	3.00	6-1659	171.45	3.20
6-1592	142.90	3.20	6-1635	11.80	1.80	6-1660	115.00	5.33
6-1593	165.10	3.20	6-1636	13.00	1.80	6-1661	64.00	4.00
6-1594	152.40	3.20	6-1637	9.55	1.75	6-1662	77.50	2.00
6-1605	156.00	4.00	6-1638	20.95	2.62	6-1663	294.00	3.00
6-1607	67.00	4.00	6-1639	351.21	4.00	6-1664	1.33	1.61
6-1608	538.00	6.00	6-1640	10.00	4.00	6-1665	94.00	5.70
6-1609	74.60	3.53	6-1641	546.00	2.62	6-1666	58.00	3.75
6-1610	17.64	2.00	6-1642	7.60	2.10	6-1667	278.99	2.62
6-1611	23.47	2.40	6-1643	54.00	3.15	6-1668	246.00	3.00
6-1612	164.00	2.00	6-1644	110.00	3.50	6-1670	2.00	1.40
6-1613	27.00	1.40	6-1645	3.40	1.50			

PTFE-O-RINGS

These O-rings can be manufactured with inside diameters from 3 to 735 mm and cross-sections from 1.0 to 20 mm

PTFE and FEP Encapsulated O-Rings

These O-rings are manufactured for standard inch sizes: metric and special sizes are available upon request.

Ultrathin®-O-Rings

Please Note: Depending on the production method and inspection criteria, PDF-Ultrathin®-O-rings do not meet all requirements of the DIN 3771.

This must be considered during assembly.

If you need more detailed information concerning PDF-Ultrathin®-O-rings please contact our Application Engineers in Bietigheim-Bissingen.

O-Ring sizes

Parker No.	Inside diameter mm	Cross section mm	Parker No.	Inside diameter mm	Cross section mm	Parker No.	Inside diameter mm	Cross section mm
2-001	0.74	1.02	6-615	3.00	2.00	6-1036	4.60	2.00
6-408	0.80	1.60	6-1120	3.00	2.70	6-133	4.70	1.90
6-1615	0.83	1.63	5-683	3.10	1.60	6-849	4.80	0.75
6-1358	0.90	0.53	6-1479	3.15	1.50	5-581	4.90	1.90
6-1410	1.00	0.63	6-736	3.17	1.02	6-1026	5.00	1.00
6-906	1.00	1.00	6-684	3.20	1.02	6-583	5.00	1.20
2-002	1.07	1.27	6-686	3.20	1.60	6-069	5.00	1.50
2-102	1.24	2.62	6-361	3.30	2.40	6-1434	5.00	1.60
6-1664	1.33	1.61	6-307	3.33	1.02	6-955	5.00	1.75
2-003	1.42	1.52	5-190	3.35	1.78	6-1488	5.00	1.90
6-1506	1.42	1.58	6-1645	3.40	1.50	6-110	5.00	2.00
6-1495	1.45	1.75	5-579	3.40	1.90	6-1035	5.00	2.50
6-1269	1.50	0.60	6-685	3.40	2.00	6-1394	5.15	1.80
6-369	1.50	1.00	6-973	3.50	0.80	2-107	5.23	2.62
6-1247	1.53	0.97	6-491	3.50	1.10	2-009	5.28	1.78
5-051	1.78	1.02	6-021	3.50	1.20	6-751	5.30	2.40
2-004	1.78	1.78	6-402	3.50	1.25	6-738	5.33	1.02
6-714	1.80	1.00	6-1532	3.50	1.35	6-063	5.35	1.50
6-418	1.85	1.50	6-468	3.50	1.50	6-1501	5.46	0.89
6-364	1.98	0.84	2-105	3.63	2.62	6-968	5.50	1.50
6-797	2.00	1.00	2-007	3.68	1.78	6-950	5.50	2.00
6-1670	2.00	1.40	6-251	3.70	1.90	6-1385	5.60	1.80
6-925	2.06	0.66	6-1568	3.80	1.90	6-338	5.60	2.40
2-103	2.06	2.62	6-166	3.90	1.80	6-960	5.61	1.68
6-1264	2.20	1.00	6-1496	3.90	1.80	6-1102	5.69	1.14
6-306	2.20	1.60	6-1363	3.90	2.40	6-748	5.70	1.05
6-880	2.30	1.30	6-613	4.00	1.00	5-582	5.70	1.90
6-1019	2.35	1.00	6-019	4.00	1.10	6-548	5.70	3.20
6-538	2.40	1.90	6-035	4.00	1.50	6-861	5.80	0.75
6-966	2.50	1.00	6-1287	4.00	1.80	2-202	5.94	3.53
6-167	2.50	1.20	6-104	4.00	2.00	6-543	6.00	1.00
6-138	2.50	1.30	6-420	4.00	2.20	6-713	6.00	1.25
6-168	2.50	1.70	6-428	4.00	2.50	6-038	6.00	1.50
2-005	2.57	1.78	6-994	4.00	3.00	6-1312	6.00	1.52
5-578	2.60	1.90	6-1405	4.05	1.77	6-1471	6.00	1.80
6-020	2.70	1.50	5-580	4.20	1.90	6-001	6.00	2.00
6-1033	2.80	1.60	2-201	4.34	3.53	6-1327	6.00	2.50
2-104	2.84	2.62	2-106	4.42	2.62	6-079	6.00	5.00
6-487	2.90	1.02	5-108	4.47	1.27	6-652	6.00	5.20
2-006	2.90	1.78	2-008	4.47	1.78	2-108	6.02	2.62
6-018	3.00	1.00	6-401	4.50	1.00	6-1581	6.07	1.30
6-549	3.00	1.20	6-214	4.50	1.50	3-902	6.07	1.63
6-441	3.00	1.50	6-1291	4.50	2.25	2-010	6.07	1.78

O-Ring sizes

Parker No.	Inside diameter mm	Cross section mm	Parker No.	Inside diameter mm	Cross section mm	Parker No.	Inside diameter mm	Cross section mm
6-344	6.20	1.50	6-1500	7.52	3.51	5-700	9.00	3.00
6-374	6.30	1.60	2-203	7.52	3.53	6-1122	9.00	3.00
6-855	6.30	1.80	2-109	7.59	2.62	6-651	9.00	4.00
5-686	6.30	2.39	6-1538	7.60	1.90	6-1530	9.10	1.60
6-1268	6.30	2.40	6-1642	7.60	2.10	6-1531	9.10	1.65
6-1251	6.36	0.72	3-903	7.65	1.63	2-204	9.12	3.53
6-933	6.40	1.30	2-011	7.65	1.78	2-110	9.19	2.62
5-583	6.40	1.90	6-1422	7.65	2.00	5-716	9.19	3.00
6-1149	6.50	1.20	6-1032	7.70	2.00	6-1487	9.20	2.70
6-581	6.50	1.50	5-673	7.75	1.88	2-012	9.25	1.78
6-572	6.50	2.00	6-317	7.80	3.60	6-866	9.30	1.50
6-480	6.60	1.50	6-486	7.80	4.60	6-012	9.30	2.40
6-1022	6.75	1.78	6-437	8.00	1.00	6-395	9.35	1.60
6-907	6.80	1.80	6-592	8.00	1.25	6-346	9.40	2.10
6-440	6.80	2.00	6-658	8.00	1.40	6-952	9.50	1.00
5-052	6.86	1.78	6-074	8.00	1.50	6-1542	9.50	1.50
6-657	7.00	1.00	6-1562	8.00	1.60	6-1314	9.50	1.78
6-959	7.00	1.20	5-585	8.00	1.88	6-1407	9.50	1.80
6-922	7.00	1.40	6-002	8.00	2.00	6-1297	9.50	2.00
6-1558	7.00	1.47	6-520	8.00	2.20	6-1511	9.50	2.15
6-011	7.00	1.50	6-564	8.00	2.50	6-1206	9.50	2.50
6-311	7.00	2.00	6-390	8.00	3.00	6-1133	9.52	1.78
6-937	7.00	2.35	6-192	8.10	1.60	6-373	9.53	1.60
6-028	7.00	2.50	6-1416	8.10	2.00	6-1440	9.55	1.75
6-1400	7.00	2.75	5-664	8.13	1.78	6-1637	9.55	1.75
6-080	7.00	3.00	6-345	8.20	1.50	6-1499	9.60	2.00
6-1523	7.10	1.37	6-070	8.30	2.40	5-212	9.75	1.78
6-052	7.10	1.60	6-692	8.50	1.50	6-1502	9.78	1.27
6-956	7.10	2.00	6-1228	8.50	2.00	6-1656	9.86	1.78
6-1321	7.10	3.60	6-1539	8.55	1.75	5-614	9.93	2.62
5-584	7.20	1.90	6-1481	8.56	1.07	6-116	10.00	1.00
6-1266	7.30	2.40	6-1286	8.65	2.80	6-1518	10.00	1.20
6-162	7.30	2.70	5-612	8.74	1.78	6-1648	10.00	1.25
6-1249	7.30	3.40	6-277	8.79	1.14	6-083	10.00	1.50
6-710	7.50	1.00	6-715	8.80	1.00	6-1216	10.00	1.60
6-661	7.50	1.25	5-586	8.90	1.90	6-003	10.00	2.00
6-091	7.50	1.50	5-587	8.90	2.70	6-532	10.00	2.20
6-1519	7.50	1.50	3-904	8.92	1.83	6-105	10.00	2.50
6-856	7.50	1.80	6-610	9.00	1.20	6-910	10.00	2.62
6-432	7.50	2.00	6-010	9.00	1.50	6-823	10.00	2.65
6-1183	7.50	2.10	6-120	9.00	1.80	6-605	10.00	3.00
6-134	7.50	2.50	6-470	9.00	2.00	6-1640	10.00	4.00
6-1570	7.50	3.00	6-161	9.00	2.50	6-931	10.00	6.50

O-Ring sizes

Parker No.	Inside diameter mm	Cross section mm	Parker No.	Inside diameter mm	Cross section mm	Parker No.	Inside diameter mm	Cross section mm
6-1449	10.00	8.00	6-1454	11.50	2.30	5-616	13.11	2.62
6-627	10.10	1.00	6-945	11.50	2.50	6-129	13.23	1.78
6-1491	10.10	1.60	6-1323	11.60	1.20	6-1198	13.30	1.20
6-839	10.10	1.78	6-1275	11.60	2.20	6-929	13.30	2.40
6-571	10.15	1.40	6-1468	11.75	1.55	6-1202	13.30	3.00
6-1460	10.20	1.50	6-1635	11.80	1.80	6-348	13.40	2.10
6-375	10.25	1.40	6-1485	11.80	2.65	3-907	13.46	2.08
6-475	10.30	2.40	6-366	11.89	1.78	6-1571	13.50	1.50
6-965	10.40	1.00	3-906	11.89	1.98	6-096	13.50	2.75
2-309	10.46	5.33	5-615	11.91	2.62	5-590	13.59	2.69
6-976	10.50	1.50	6-438	12.00	1.00	6-1504	13.59	2.69
5-588	10.50	2.70	6-1566	12.00	1.20	6-473	13.60	2.50
3-905	10.52	1.83	6-1466	12.00	1.30	2-311	13.64	5.33
6-777	10.60	1.80	6-1469	12.00	1.40	6-1339	13.70	2.50
6-218	10.60	2.00	6-053	12.00	1.50	6-160	13.75	2.80
2-205	10.69	3.53	6-065	12.00	2.00	2-207	13.87	3.53
2-111	10.77	2.62	6-774	12.00	2.50	6-737	13.89	1.30
6-1505	10.78	2.62	6-124	12.00	3.00	2-113	13.94	2.62
6-551	10.80	1.50	6-662	12.00	3.80	6-1288	14.00	1.00
6-1230	10.80	1.90	6-1330	12.00	10.60	6-1049	14.00	1.10
2-013	10.82	1.78	2-310	12.07	5.33	6-1576	14.00	1.30
6-1208	10.90	1.20	6-1361	12.10	1.60	6-143	14.00	1.50
6-1236	11.00	1.00	5-589	12.10	2.70	6-1345	14.00	1.60
6-084	11.00	1.50	2-206	12.29	3.53	2-015	14.00	1.78
6-1516	11.00	1.60	6-058	12.30	2.40	6-1342	14.00	1.82
6-086	11.00	2.00	2-112	12.37	2.62	6-090	14.00	2.00
6-717	11.00	2.50	2-014	12.42	1.78	6-1555	14.00	2.20
6-953	11.00	3.00	6-550	12.50	1.10	6-067	14.00	2.50
6-1386	11.00	3.40	6-1567	12.50	1.50	6-705	14.00	3.00
6-1525	11.10	1.60	6-1379	12.50	1.80	6-1537	14.20	1.90
5-613	11.10	1.78	6-198	12.50	2.00	6-135	14.30	2.40
6-1337	11.10	1.82	6-1503	12.83	1.27	6-1658	14.40	2.00
6-1510	11.10	2.15	6-584	13.00	1.00	5-239	14.48	2.69
6-1376	11.20	1.80	6-904	13.00	1.30	6-397	14.50	1.60
6-1492	11.30	1.50	6-1526	13.00	1.30	6-1464	14.50	3.00
6-1536	11.30	2.20	6-033	13.00	1.50	6-340	14.60	2.40
6-471	11.30	2.40	6-1484	13.00	1.58	6-1393	14.70	3.50
6-347	11.40	2.10	6-1636	13.00	1.80	6-683	15.00	1.00
6-677	11.50	1.00	6-075	13.00	2.00	6-118	15.00	1.50
6-928	11.50	1.50	6-016	13.00	2.50	6-040	15.00	1.60
6-1575	11.50	1.78	6-730	13.00	3.00	6-085	15.00	1.80
6-1498	11.50	1.80	6-207	13.00	3.50	6-005	15.00	2.00
6-1313	11.50	2.00	6-163	13.10	1.60	6-106	15.00	2.50

O-Ring sizes

Parker No.	Inside diameter mm	Cross section mm	Parker No.	Inside diameter mm	Cross section mm	Parker No.	Inside diameter mm	Cross section mm
6-043	15.00	3.00	2-313	16.81	5.33	6-499	18.60	2.00
6-072	15.00	3.20	5-592	16.90	2.70	6-557	18.60	3.50
6-1398	15.00	3.50	6-524	17.00	1.10	2-210	18.64	3.53
6-1099	15.00	4.00	6-476	17.00	1.50	2-116	18.72	2.62
6-128	15.00	5.00	6-044	17.00	2.00	2-018	18.77	1.78
6-1396	15.08	2.62	6-946	17.00	3.00	6-1543	18.80	1.90
6-1548	15.10	2.60	6-974	17.00	3.50	6-295	19.00	0.80
5-591	15.10	2.70	6-1365	17.00	4.00	6-1276	19.00	1.00
2-312	15.24	5.33	2-209	17.04	3.53	6-573	19.00	1.50
6-940	15.30	2.20	2-115	17.12	2.62	6-798	19.00	1.80
6-206	15.30	2.40	2-017	17.17	1.78	6-360	19.00	2.00
5-243	15.34	2.62	6-1341	17.20	1.82	6-039	19.00	2.50
6-349	15.40	2.10	6-1109	17.20	3.00	6-779	19.00	2.65
2-208	15.47	3.53	6-1569	17.30	2.20	6-998	19.00	3.00
5-676	15.49	1.47	5-690	17.30	2.40	6-404	19.00	5.00
6-1541	15.50	1.50	6-554	17.40	2.10	3-910	19.18	2.46
6-1340	15.50	2.60	6-388	17.40	2.50	6-593	19.20	3.00
2-114	15.54	2.62	6-1364	17.50	4.00	6-503	19.30	2.40
2-016	15.60	1.78	6-1610	17.64	2.00	6-628	19.30	3.65
6-1494	15.70	2.50	6-1480	17.70	1.78	6-1430	19.35	1.00
6-223	15.80	2.40	6-367	17.81	1.02	6-350	19.40	2.10
5-617	15.88	2.62	6-1298	17.86	2.62	6-119	19.50	1.50
6-439	16.00	1.00	6-041	17.90	1.25	6-1463	19.50	3.50
6-632	16.00	1.25	5-256	17.96	2.62	6-758	19.75	2.50
6-528	16.00	1.50	6-258	17.96	2.62	6-300	19.80	2.40
6-857	16.00	1.80	6-731	18.00	1.30	5-595	19.80	3.60
6-146	16.00	2.00	6-087	18.00	1.50	2-315	19.99	5.33
6-562	16.00	2.50	6-076	18.00	2.00	6-099	20.00	1.30
6-891	16.00	2.65	6-1040	18.00	2.20	6-078	20.00	1.50
6-042	16.00	3.00	6-132	18.00	2.50	6-793	20.00	1.80
6-1021	16.00	4.00	6-425	18.00	3.00	6-619	20.00	2.00
6-1432	16.00	6.00	6-007	18.00	3.15	6-017	20.00	2.50
6-1524	16.30	1.40	6-125	18.00	4.00	6-1373	20.00	2.65
6-1039	16.30	2.40	6-755	18.00	5.00	6-130	20.00	3.00
3-908	16.36	2.21	6-1586	18.00	10.00	6-808	20.00	3.55
6-876	16.50	1.00	6-848	18.14	1.78	6-958	20.00	4.00
6-1579	16.50	1.50	6-396	18.20	3.00	6-1091	20.00	5.00
6-1493	16.50	2.00	6-1549	18.20	2.60	6-382	20.20	3.00
6-313	16.50	2.70	6-177	18.30	2.40	2-211	20.22	3.53
5-643	16.51	1.14	5-594	18.30	3.60	2-117	20.29	2.62
6-725	16.56	1.78	5-593	18.40	2.70	6-275	20.30	2.40
6-297	16.58	1.50	2-314	18.42	5.33	6-212	20.34	4.25
6-006	16.70	1.45	6-308	18.50	1.50	2-019	20.35	1.78

O-Ring sizes

Parker No.	Inside diameter mm	Cross section mm	Parker No.	Inside diameter mm	Cross section mm	Parker No.	Inside diameter mm	Cross section mm
6-1465	20.50	2.00	5-597	23.00	3.60	6-289	25.79	1.00
6-1490	20.50	3.00	6-1431	23.00	4.00	6-387	25.80	3.30
6-1638	20.95	2.62	6-1433	23.00	6.00	5-618	25.81	3.53
6-1353	21.00	1.00	2-317	23.16	5.33	6-728	26.00	1.00
6-1470	21.00	1.50	2-213	23.39	3.53	6-1232	26.00	1.50
6-008	21.00	2.00	6-1611	23.47	2.40	6-656	26.00	2.00
6-1311	21.00	3.00	2-119	23.47	2.62	6-749	26.00	2.50
6-089	21.00	3.50	3-912	23.47	2.95	6-1082	26.00	3.00
6-1252	21.00	4.00	2-021	23.52	1.78	6-1259	26.00	4.00
6-489	21.00	6.00	6-298	23.60	1.02	5-599	26.20	3.60
6-1375	21.20	1.80	6-942	23.60	2.90	2-319	26.34	5.33
6-430	21.20	2.40	6-351	23.70	2.80	6-1655	26.50	4.00
6-780	21.20	2.65	6-1338	23.80	2.40	2-215	26.57	3.53
6-801	21.20	3.55	6-666	24.00	1.00	3-914	26.59	2.95
6-1446	21.30	2.30	6-544	24.00	1.50	2-121	26.64	2.62
5-596	21.30	3.60	6-022	24.00	2.00	2-023	26.70	1.78
6-1590	21.50	1.00	6-595	24.00	2.50	6-208	26.70	2.50
6-687	21.50	1.50	6-1027	24.00	3.00	6-1613	27.00	1.40
6-343	21.50	1.78	6-453	24.00	4.00	6-400	27.00	1.50
2-316	21.59	5.33	6-443	24.00	6.00	6-049	27.00	2.00
6-285	21.70	0.73	6-050	24.20	3.00	6-894	27.00	2.50
2-212	21.82	3.53	6-288	24.32	1.00	6-1447	27.00	2.70
2-118	21.89	2.62	6-1545	24.50	1.00	6-147	27.00	3.00
3-911	21.92	2.95	6-1289	24.50	3.15	6-825	27.00	3.20
2-020	21.95	1.78	6-1456	24.60	3.40	6-660	27.00	5.00
6-1115	22.00	1.30	5-598	24.60	3.60	6-913	27.20	3.00
6-493	22.00	1.39	6-1204	24.69	1.78	6-023	27.30	2.40
6-088	22.00	1.50	2-318	24.77	5.33	6-497	27.50	1.50
6-139	22.00	2.00	6-092	24.80	1.50	6-1540	27.50	2.00
6-1315	22.00	2.10	2-214	24.99	3.53	6-296	27.71	1.02
6-036	22.00	2.50	6-611	25.00	1.50	5-600	27.80	3.60
6-1083	22.00	3.00	6-442	25.00	2.00	2-320	27.94	5.33
6-877	22.00	4.00	6-916	25.00	2.50	6-905	28.00	1.00
6-356	22.10	1.60	6-969	25.00	3.00	6-101	28.00	1.50
6-1064	22.20	3.00	6-426	25.00	4.00	6-794	28.00	1.80
6-1550	22.20	3.10	6-376	25.00	5.00	6-140	28.00	2.00
6-1086	22.30	2.40	3-913	25.04	2.95	6-180	28.00	2.20
6-263	22.70	1.50	2-120	25.07	2.62	6-654	28.00	2.50
6-287	22.89	1.00	2-022	25.12	1.78	6-781	28.00	2.65
6-1078	23.00	1.50	6-126	25.30	1.60	6-977	28.00	3.00
6-999	23.00	2.00	6-745	25.30	2.40	6-1533	28.00	4.00
6-066	23.00	2.50	6-189	25.50	2.00	6-1031	28.00	5.00
6-1112	23.00	3.00	6-957	25.60	1.93	2-216	28.17	3.53

O-Ring sizes

Parker No.	Inside diameter mm	Cross section mm	Parker No.	Inside diameter mm	Cross section mm	Parker No.	Inside diameter mm	Cross section mm
6-1378	28.20	1.00	6-1512	32.00	1.50	6-377	35.00	5.30
2-122	28.24	2.62	6-1556	32.00	1.50	6-1124	35.15	3.15
2-024	28.30	1.78	6-869	32.00	2.00	6-1650	35.50	4.00
6-1551	28.30	3.10	6-850	32.00	2.50	5-605	35.60	3.60
6-1423	29.00	2.50	6-646	32.00	2.70	6-980	36.00	1.50
6-1000	29.00	3.00	6-838	32.00	4.00	6-678	36.00	2.00
6-1517	29.10	1.60	6-1634	32.50	3.00	6-981	36.00	2.00
5-601	29.30	3.60	6-784	32.50	3.55	6-694	36.00	2.10
6-034	29.50	1.50	5-603	32.50	3.60	6-609	36.00	2.20
2-321	29.51	5.33	2-323	32.69	5.33	6-329	36.00	2.50
6-352	29.70	2.80	2-219	32.92	3.53	6-923	36.00	3.00
3-916	29.74	2.95	2-125	32.99	2.62	6-1140	36.00	3.00
2-217	29.74	3.53	6-136	33.00	2.00	6-1652	36.00	5.00
2-123	29.82	2.62	6-540	33.00	2.50	2-221	36.09	3.53
2-025	29.87	1.78	6-1138	33.00	3.00	2-127	36.17	2.62
6-1627	30.00	1.00	6-1411	33.00	3.50	6-1087	36.20	3.00
6-048	30.00	2.00	6-1614	33.00	5.00	6-154	36.30	1.78
6-1203	30.00	2.15	2-027	33.05	1.78	5-670	36.50	1.78
6-1474	30.00	2.25	6-472	33.30	2.40	6-970	37.00	1.50
6-156	30.00	2.50	6-802	33.50	2.65	6-1188	37.00	2.00
6-056	30.00	3.00	5-157	33.99	2.34	6-291	37.00	2.50
6-037	30.00	3.15	6-1047	34.00	1.00	6-881	37.00	3.00
6-803	30.00	3.55	6-1197	34.00	2.00	6-1187	37.00	3.00
6-454	30.00	4.00	6-1631	34.00	2.50	6-555	37.00	5.00
6-663	30.00	4.65	6-622	34.00	2.80	5-606	37.30	3.60
6-1366	30.00	5.00	6-914	34.00	3.00	6-459	37.36	2.60
6-290	30.30	2.40	5-604	34.10	3.60	3-920	37.47	3.00
6-142	30.70	2.00	2-324	34.29	5.33	2-325	37.47	5.33
5-602	30.80	3.60	6-1150	34.40	2.10	6-1257	37.50	4.00
6-1478	31.00	1.50	6-585	34.40	3.10	2-222	37.69	3.53
6-1401	31.00	2.00	3-918	34.42	2.95	2-128	37.77	2.62
6-324	31.00	2.50	2-220	34.52	3.53	2-029	37.82	1.78
6-1578	31.00	4.00	2-126	34.59	2.62	6-1589	38.00	1.00
6-097	31.00	4.50	2-028	34.65	1.78	6-1389	38.00	1.50
6-314	31.02	3.00	6-752	34.65	2.60	6-046	38.00	2.00
2-322	31.12	5.33	6-1100	35.00	1.50	6-433	38.00	2.50
2-218	31.34	3.53	6-047	35.00	2.00	6-1092	38.00	3.00
2-124	31.42	2.62	6-606	35.00	2.50	6-1025	38.00	3.50
2-026	31.47	1.78	6-1116	35.00	3.00	6-221	38.00	5.00
6-1146	31.50	3.15	6-993	35.00	3.20	6-1412	38.00	5.00
6-1461	31.57	1.98	6-1166	35.00	4.00	6-782	38.70	2.65
6-766	31.70	3.50	6-545	35.00	4.50	6-353	38.70	2.80
6-760	31.95	2.60	6-1414	35.00	5.00	6-575	39.00	2.00

O-Ring sizes

Parker No.	Inside diameter mm	Cross section mm	Parker No.	Inside diameter mm	Cross section mm	Parker No.	Inside diameter mm	Cross section mm
6-1038	39.00	3.00	6-1060	43.00	4.00	2-134	47.29	2.62
6-1482	39.00	5.00	6-1413	43.00	5.50	2-032	47.35	1.78
6-205	39.20	3.00	6-759	43.25	2.60	6-009	47.50	4.00
6-1362	39.20	5.70	6-809	43.70	1.80	6-370	48.00	2.00
2-129	39.34	2.62	2-327	43.82	5.33	6-155	48.00	3.00
6-1148	39.40	2.10	6-431	44.00	2.00	6-1196	48.00	4.00
6-586	39.40	3.10	6-1054	44.00	3.00	6-673	48.20	1.78
6-753	39.50	2.60	2-224	44.04	3.53	6-435	48.40	4.85
5-321	39.60	3.53	2-132	44.12	2.62	2-135	48.90	2.62
6-642	40.00	1.50	2-031	44.17	1.78	6-1253	49.00	2.00
6-027	40.00	2.00	6-542	44.20	2.50	6-912	49.20	3.00
6-566	40.00	2.50	6-1349	44.30	5.70	5-701	49.20	3.53
6-292	40.00	3.00	6-1520	44.35	2.58	6-1285	49.20	3.53
6-1497	40.00	4.00	6-193	44.35	3.00	6-1070	49.20	5.70
6-1023	40.00	5.00	6-772	44.70	3.50	6-194	49.50	3.00
6-1267	40.00	5.00	6-975	44.83	2.67	6-051	50.00	2.00
6-1114	40.00	6.00	6-882	45.00	1.00	6-055	50.00	2.50
6-102	40.60	4.00	6-082	45.00	1.50	6-964	50.00	3.00
2-326	40.64	5.33	6-054	45.00	2.00	6-1437	50.00	3.50
6-972	40.82	2.59	6-323	45.00	2.50	6-603	50.00	4.00
2-223	40.87	3.53	6-783	45.00	2.65	6-791	50.00	4.50
2-130	40.94	2.62	6-997	45.00	3.00	6-1226	50.00	5.00
6-1144	41.00	1.50	6-1178	45.00	4.00	2-329	50.17	5.33
2-030	41.00	1.78	6-1195	45.00	4.50	6-1489	50.20	3.00
6-541	41.00	2.50	6-726	45.00	5.00	2-226	50.39	3.53
6-449	41.00	3.00	5-035	45.36	3.53	2-136	50.47	2.62
6-525	41.28	3.53	2-133	45.69	2.62	2-033	50.52	1.78
6-337	41.40	2.62	6-750	45.90	1.50	6-630	51.00	3.00
6-875	41.60	2.40	6-1176	46.00	2.00	6-434	51.50	1.50
6-414	41.75	2.60	6-1020	46.00	3.00	5-037	51.71	3.53
6-1486	42.00	1.00	6-944	46.00	4.00	6-1333	51.94	3.53
6-015	42.00	1.50	6-1248	46.00	5.00	6-1587	52.00	1.00
6-594	42.00	2.50	6-159	46.02	3.53	6-1234	52.00	2.50
6-227	42.00	3.00	6-354	46.70	2.80	6-556	52.00	3.00
6-1319	42.00	4.00	6-423	46.87	2.62	2-137	52.07	2.62
6-1399	42.00	4.50	2-328	46.99	5.33	6-893	52.20	5.70
6-1224	42.00	5.00	6-1141	47.00	2.00	6-1185	52.50	1.80
6-845	42.50	1.80	6-1041	47.00	2.50	6-778	53.00	1.80
2-131	42.52	2.62	6-1633	47.00	3.00	6-1347	53.00	2.00
5-330	42.52	5.33	6-1059	47.00	4.00	6-1024	53.00	3.50
5-332	42.85	3.53	6-1483	47.00	5.50	6-113	53.00	5.00
6-1189	43.00	2.00	6-293	47.20	5.70	6-112	53.00	6.50
6-996	43.00	3.00	2-225	47.22	3.53	3-928	53.09	3.00

O-Ring sizes

Parker No.	Inside diameter mm	Cross section mm	Parker No.	Inside diameter mm	Cross section mm	Parker No.	Inside diameter mm	Cross section mm
2-330	53.34	5.33	3-932	59.36	3.00	6-501	65.00	2.00
6-1657	53.50	2.00	6-764	59.60	5.85	6-1377	65.00	2.65
2-227	53.57	3.53	2-332	59.69	5.33	6-523	65.00	3.00
2-138	53.64	2.62	6-560	59.70	7.00	6-1053	65.00	4.00
2-034	53.70	1.78	2-229	59.92	3.53	6-596	65.00	4.50
6-1317	53.80	4.00	2-142	59.99	2.62	6-1037	65.00	5.00
6-1513	54.00	1.50	6-883	60.00	1.20	6-416	65.00	5.30
6-1184	54.00	2.00	6-411	60.00	2.50	5-703	65.09	3.53
6-1274	54.00	2.00	6-665	60.00	3.00	6-500	66.00	2.00
6-819	54.00	3.00	6-107	60.00	4.10	6-1193	66.00	3.00
6-1643	54.00	3.15	6-1368	60.00	4.50	6-1273	66.00	5.00
6-879	54.00	4.00	6-114	60.00	5.00	2-334	66.04	5.33
6-664	54.00	4.65	2-036	60.05	1.78	2-231	66.27	3.53
6-1552	54.40	4.25	6-851	61.00	2.00	2-146	66.34	2.62
6-810	54.50	2.65	6-1034	61.00	4.00	2-038	66.40	1.78
6-1438	54.70	3.53	6-633	61.00	4.50	6-243	67.00	1.50
6-141	55.00	2.00	6-792	61.00	5.00	6-316	67.00	2.50
6-1065	55.00	3.00	2-143	61.60	2.62	6-659	67.00	3.00
6-1192	55.00	3.50	6-1439	61.70	4.50	6-786	67.00	3.55
6-1186	55.00	4.00	6-1419	62.00	1.50	6-1607	67.00	4.00
6-1448	55.00	5.00	6-455	62.00	2.50	5-361	67.84	3.53
2-139	55.25	2.62	6-699	62.00	3.00	2-147	67.95	2.62
6-703	55.30	2.00	6-1209	62.00	3.53	6-884	68.00	3.00
6-568	56.00	2.00	6-1104	62.00	4.00	6-1380	68.00	3.50
6-985	56.00	3.00	6-1261	62.00	4.00	6-1272	68.00	4.00
6-785	56.00	3.55	6-1117	62.00	6.00	6-941	68.00	5.00
6-1145	56.00	4.00	2-333	62.87	5.33	6-990	69.00	2.50
2-331	56.52	5.33	6-242	63.00	2.50	6-824	69.00	3.00
6-1271	56.70	3.00	6-1162	63.00	3.50	2-335	69.22	5.33
2-228	56.74	3.53	6-151	63.00	4.00	6-272	69.24	3.40
2-140	56.82	2.62	6-474	63.00	4.50	2-232	69.44	3.53
2-035	56.87	1.78	6-1094	63.00	6.00	2-148	69.52	2.62
6-643	57.00	1.50	2-230	63.09	3.53	2-039	69.57	1.78
6-719	57.00	2.50	2-144	63.17	2.62	6-552	70.00	2.00
6-427	57.00	3.00	2-037	63.22	1.78	6-1462	70.00	2.50
6-1137	57.00	4.00	6-636	64.00	3.00	6-031	70.00	3.00
6-109	58.00	4.00	6-1661	64.00	4.00	6-1554	70.00	3.50
6-447	58.00	2.00	6-1123	64.20	5.70	6-1194	70.00	4.00
6-1354	58.00	3.00	5-805	64.39	1.78	6-539	70.00	4.50
6-1666	58.00	3.75	6-852	64.39	1.78	6-899	70.00	5.00
2-141	58.42	2.62	2-145	64.77	2.62	6-1212	70.00	8.00
5-702	58.74	3.53	6-1588	65.00	1.00	6-787	71.00	3.55
6-1585	59.20	5.70	6-1372	65.00	1.80	6-634	71.00	4.50

O-Ring sizes

Parker No.	Inside diameter mm	Cross section mm	Parker No.	Inside diameter mm	Cross section mm	Parker No.	Inside diameter mm	Cross section mm
2-149	71.12	2.62	6-1152	79.20	5.70	6-574	86.84	5.33
5-704	71.44	3.53	6-992	79.30	2.62	6-579	87.00	3.00
6-979	72.00	2.50	6-195	79.50	3.00	6-558	87.20	2.50
6-045	72.00	3.00	6-108	79.60	3.20	6-1016	87.20	5.70
6-1013	72.00	4.00	6-790	80.00	1.80	6-309	87.30	2.00
2-336	72.39	5.33	6-569	80.00	2.00	6-276	88.00	3.00
2-233	72.62	3.53	6-1270	80.00	3.00	6-1052	88.00	4.00
2-150	72.69	2.62	6-1316	80.00	3.50	6-1629	88.00	5.00
2-040	72.75	1.78	6-788	80.00	3.55	6-1165	88.00	6.00
6-1628	73.00	2.00	6-1057	80.00	4.00	6-1111	88.00	8.00
6-030	73.00	3.00	6-1181	80.00	5.00	2-341	88.27	5.33
6-757	73.00	4.00	5-816	80.31	1.78	5-381	88.27	6.99
6-1348	73.00	7.00	6-885	80.50	4.00	6-561	88.30	7.00
6-178	74.00	2.00	6-121	81.00	3.00	2-238	88.49	3.53
6-483	74.00	3.00	6-1077	81.00	4.00	6-1508	88.50	6.50
6-294	74.20	5.70	2-339	81.92	5.33	2-153	88.57	2.62
6-587	74.40	3.10	6-513	82.00	2.00	2-043	88.62	1.78
6-1609	74.60	3.53	6-1472	82.00	3.00	6-867	89.20	5.70
5-705	74.61	3.53	6-445	82.00	4.00	6-013	89.50	3.00
6-1357	75.00	2.50	2-236	82.14	3.53	6-763	89.60	5.70
6-1075	75.00	3.00	2-152	82.22	2.62	6-498	90.00	2.00
6-1001	75.00	4.00	2-042	82.27	1.78	6-1113	90.00	2.50
2-337	75.57	5.33	6-821	83.00	1.00	6-216	90.00	3.00
2-234	75.79	3.53	6-900	83.00	3.00	6-1179	90.00	4.00
2-151	75.87	2.62	6-184	83.80	2.62	6-1265	90.00	4.80
2-041	75.92	1.78	6-676	84.00	2.50	6-1214	90.00	5.00
6-1369	76.00	2.00	6-456	84.00	3.00	6-1103	90.00	7.00
6-754	76.00	2.50	6-1134	84.00	3.50	6-1429	91.00	2.00
6-921	76.00	3.00	6-1012	84.30	5.70	6-100	91.00	3.00
6-464	76.00	4.50	6-588	84.40	3.10	2-342	91.44	5.33
6-805	77.00	2.00	6-822	85.00	1.50	2-239	91.67	3.53
6-1417	77.00	2.50	6-733	85.00	2.00	6-1452	92.00	3.00
6-1069	77.10	2.62	6-1014	85.00	3.00	6-1061	92.00	4.00
6-1662	77.50	2.00	6-853	85.00	4.00	6-1507	92.20	2.62
6-1467	77.50	2.62	6-1445	85.00	5.00	6-804	92.50	3.55
6-1475	78.00	2.00	6-1174	85.00	6.00	6-720	93.00	2.00
6-978	78.00	2.50	6-1406	85.00	6.99	6-743	93.00	3.00
6-729	78.00	3.00	2-340	85.09	5.33	6-963	93.00	4.00
6-826	78.00	3.50	6-452	85.20	9.25	6-1056	93.00	5.00
6-1002	78.00	5.00	2-237	85.32	3.53	6-257	93.39	1.47
2-338	78.74	5.33	6-991	86.00	2.62	6-405	93.50	9.50
2-235	78.97	3.53	6-1457	86.00	4.00	6-446	94.00	2.00
6-820	79.00	1.50	6-1573	86.50	4.00	6-1095	94.00	3.00

O-Ring sizes

Parker No.	Inside diameter mm	Cross section mm	Parker No.	Inside diameter mm	Cross section mm	Parker No.	Inside diameter mm	Cross section mm
6-1029	94.00	4.00	2-243	104.37	3.53	6-1660	115.00	5.33
6-1665	94.00	5.70	6-1175	104.50	3.00	6-1421	115.00	6.00
6-608	94.20	5.70	6-589	105.00	2.00	6-1322	116.00	3.00
6-339	94.50	3.00	6-1381	105.00	3.00	6-1105	116.50	1.78
6-399	94.50	3.00	6-806	105.00	3.50	2-350	116.84	5.33
2-343	94.62	5.33	6-995	105.00	4.00	2-426	116.84	6.99
2-240	94.84	3.53	6-1074	105.00	5.00	2-247	117.07	3.53
2-154	94.92	2.62	6-253	106.80	2.66	6-032	118.00	2.00
2-044	94.97	1.78	6-1320	107.00	8.00	6-1509	118.00	4.00
6-863	95.00	4.00	6-762	107.31	6.99	6-580	118.31	3.53
6-1062	95.00	4.50	2-347	107.32	5.33	6-123	118.50	3.00
6-874	95.00	5.00	2-244	107.54	3.53	5-843	118.72	2.62
6-582	95.50	3.53	2-156	107.62	2.62	6-448	119.20	5.70
6-700	96.00	2.00	2-046	107.67	1.78	6-1515	119.60	3.20
6-832	96.00	9.00	6-1106	108.00	8.00	6-768	119.60	5.70
6-640	97.00	1.50	6-740	109.00	3.00	6-674	120.00	1.50
6-1415	97.00	4.00	6-837	109.20	5.70	6-504	120.00	3.00
6-1306	97.00	5.00	6-815	109.20	5.84	6-1076	120.00	4.00
2-344	97.79	5.33	6-767	109.40	3.10	6-1180	120.00	5.00
6-157	98.00	3.00	6-1580	110.00	1.50	6-1003	120.00	6.00
2-241	98.02	3.53	6-1367	110.00	2.50	6-1427	120.00	10.00
6-1303	99.00	3.00	6-903	110.00	3.00	2-351	120.02	5.33
6-392	99.00	6.99	6-1644	110.00	3.50	2-427	120.02	6.99
6-1089	99.20	5.70	6-915	110.00	5.00	2-248	120.24	3.53
6-601	100.00	2.00	2-348	110.49	5.33	2-158	120.32	2.62
6-174	100.00	2.50	2-245	110.72	3.53	2-048	120.37	1.78
6-1305	100.00	3.00	6-1651	112.00	2.50	6-961	122.00	3.00
6-413	100.00	4.00	6-421	112.00	3.00	6-1630	122.00	6.00
6-137	100.00	5.00	6-873	112.00	4.00	2-352	123.19	5.33
6-1395	100.00	6.00	6-1182	112.00	7.00	2-428	123.19	6.99
6-1237	100.00	8.00	2-349	113.67	5.33	2-249	123.42	3.53
2-345	100.97	5.33	2-425	113.67	6.99	6-1143	124.00	4.00
6-025	101.00	3.00	2-246	113.89	3.53	6-1281	125.00	2.50
2-242	101.19	3.53	2-157	113.97	2.62	6-612	125.00	3.00
2-155	101.27	2.62	6-982	114.00	3.00	6-1199	125.00	4.00
2-045	101.32	1.78	6-1164	114.00	5.00	6-457	125.00	5.00
6-724	102.00	3.00	2-047	114.02	1.78	6-115	125.00	8.00
6-1163	102.00	4.00	6-1005	114.20	5.70	5-850	125.09	6.60
6-1006	102.00	6.00	6-769	114.40	3.10	6-255	126.00	5.00
6-1055	103.00	5.00	6-1151	115.00	2.00	6-1572	126.00	5.10
6-1200	104.00	5.30	6-274	115.00	3.00	2-353	126.37	5.33
2-346	104.14	5.33	6-1159	115.00	5.00	2-429	126.37	6.99
6-1350	104.30	5.70	6-1169	115.00	5.00	2-250	126.59	3.53

O-Ring sizes

Parker No.	Inside diameter mm	Cross section mm	Parker No.	Inside diameter mm	Cross section mm	Parker No.	Inside diameter mm	Cross section mm
2-159	126.67	2.62	6-379	138.00	2.10	2-258	151.99	3.53
2-049	126.72	1.78	6-224	138.00	6.00	6-1553	152.00	1.78
6-722	128.00	2.00	2-357	139.07	5.33	6-1107	152.00	8.00
6-1473	128.00	3.00	2-433	139.07	6.99	2-163	152.07	2.62
6-1073	128.00	5.00	2-254	139.29	3.53	6-1594	152.40	3.20
6-1591	129.00	1.50	2-161	139.37	2.62	6-1625	154.60	1.78
6-1096	129.00	4.00	6-698	140.00	2.00	6-1294	155.00	3.00
6-451	129.20	5.70	6-511	140.00	3.00	6-1390	155.00	3.53
2-354	129.54	5.33	6-378	140.00	4.00	6-1318	155.00	4.00
2-430	129.54	6.99	6-1136	140.00	5.00	6-1324	155.00	5.00
2-251	129.77	3.53	6-602	140.00	10.00	6-773	155.00	10.00
6-693	130.00	2.50	6-1051	142.00	4.00	6-1605	156.00	4.00
6-1296	130.00	3.00	6-1093	142.00	6.00	2-362	158.12	5.33
6-1084	130.00	4.00	6-1207	142.00	12.00	2-438	158.12	6.99
6-902	130.00	5.00	2-358	142.24	5.33	2-259	158.34	3.53
6-577	130.00	6.00	2-434	142.24	6.99	2-164	158.42	2.62
6-1436	131.00	5.30	2-255	142.47	3.53	6-170	159.00	4.00
6-1217	131.50	4.00	6-1592	142.90	3.20	6-444	159.20	5.70
6-095	132.00	3.00	6-512	144.00	3.70	6-576	160.00	3.00
6-1015	132.00	4.00	6-1632	145.00	2.50	6-818	160.00	4.00
2-355	132.72	5.33	6-1233	145.00	4.00	6-1081	160.00	5.00
2-431	132.72	6.99	6-1046	145.00	5.00	6-1161	160.00	5.00
2-252	132.94	3.53	2-359	145.42	5.33	6-1292	160.00	6.00
2-160	133.02	2.62	2-435	145.42	6.99	6-103	161.00	3.00
2-050	133.07	1.78	2-256	145.64	3.53	6-1045	162.00	2.50
6-688	133.35	5.33	2-162	145.72	2.62	6-494	162.50	3.53
6-812	133.50	12.00	6-061	146.00	3.23	6-1612	164.00	2.00
6-515	134.00	3.00	6-756	148.00	10.00	6-983	164.20	5.70
6-1329	134.00	8.00	2-257	148.52	3.53	6-814	164.20	5.84
6-1277	135.00	3.00	2-360	148.59	5.33	2-363	164.47	5.33
6-059	135.00	3.23	2-436	148.59	6.99	2-439	164.47	6.99
6-060	135.00	3.43	6-623	149.20	5.70	2-260	164.69	3.53
6-844	135.00	4.00	6-932	150.00	2.00	2-165	164.77	2.62
6-1085	135.00	5.00	6-689	150.00	3.00	6-911	165.00	2.00
2-356	135.89	5.33	6-872	150.00	4.00	6-1402	165.00	4.00
2-432	135.89	6.99	6-1295	150.00	5.00	6-1529	165.00	5.00
6-1559	136.00	3.00	6-222	150.00	5.40	6-1593	165.10	3.20
6-1154	136.00	4.00	6-1147	150.00	6.00	6-1336	167.50	3.50
2-253	136.12	3.53	6-496	151.00	3.00	6-746	169.20	5.70
6-026	137.00	3.00	6-962	151.00	4.00	6-1097	170.00	4.00
6-833	137.00	4.00	6-318	151.70	5.60	6-1290	170.00	5.00
6-559	137.00	14.00	2-361	151.77	5.33	2-364	170.82	5.33
6-341	137.30	8.00	2-437	151.77	6.99	2-440	170.82	6.99

O-Ring sizes

Parker No.	Inside diameter mm	Cross section mm	Parker No.	Inside diameter mm	Cross section mm	Parker No.	Inside diameter mm	Cross section mm
6-282	171.00	11.00	6-1044	190.00	4.00	6-954	214.63	2.18
2-261	171.04	3.53	6-614	190.00	5.00	6-570	215.00	6.00
2-166	171.12	2.62	6-1646	190.00	10.00	2-371	215.27	5.33
6-1659	171.45	3.20	2-264	190.09	3.53	2-446	215.27	6.99
6-887	172.00	3.00	2-169	190.17	2.62	2-268	215.49	3.53
6-1177	172.00	4.00	6-299	191.00	1.78	2-173	215.57	2.62
6-1004	172.00	6.00	6-1260	192.00	4.00	6-1302	216.00	4.00
6-492	174.00	3.00	6-1391	192.00	8.00	6-1048	218.00	5.80
6-655	174.20	5.70	6-1238	194.00	14.00	6-1050	218.00	6.00
6-889	174.30	3.50	6-868	195.00	3.50	6-254	218.00	12.00
6-1356	175.00	5.00	6-1283	195.00	5.00	6-183	219.00	5.30
6-1068	175.00	6.00	6-1453	195.00	6.00	6-502	220.00	3.00
6-841	175.00	10.00	6-920	195.50	12.00	6-1063	220.00	5.00
6-148	177.00	2.00	6-747	196.00	4.00	6-1425	220.00	7.00
2-365	177.17	5.33	6-273	196.00	12.00	6-1560	221.00	1.78
2-441	177.17	6.99	2-368	196.22	5.33	2-372	221.62	5.33
2-262	177.39	3.53	2-444	196.22	6.99	2-269	221.84	3.53
2-167	177.47	2.62	2-265	196.44	3.53	2-174	221.92	2.62
6-631	179.00	3.00	2-170	196.52	2.62	6-1225	222.00	7.00
6-1098	179.20	5.70	6-547	197.00	3.00	6-949	223.00	5.33
6-704	180.00	3.00	6-1450	198.00	4.00	6-1654	224.00	6.00
6-1088	180.00	4.00	6-1563	198.00	8.00	6-1250	225.00	3.00
6-1280	180.00	5.00	6-1307	200.00	4.00	6-485	225.00	5.00
6-1110	180.00	6.00	6-1139	200.00	5.00	6-150	227.00	2.00
6-1119	180.00	8.00	6-226	200.00	6.00	2-373	227.97	5.33
6-862	180.00	10.00	6-865	201.00	4.00	2-447	227.97	6.99
6-1108	180.52	5.33	2-369	202.57	5.33	6-1211	228.00	3.00
5-434	180.54	6.99	2-445	202.57	6.99	2-270	228.19	3.53
2-366	183.52	5.33	2-266	202.79	3.53	2-175	228.27	2.62
2-442	183.52	6.99	2-171	202.87	2.62	6-516	230.00	3.00
2-263	183.74	3.53	6-342	204.00	8.00	6-1293	230.00	8.00
2-168	183.82	2.62	6-149	205.00	2.00	6-252	231.50	6.00
6-1058	185.00	3.00	6-546	205.00	3.00	6-918	234.10	8.40
6-1428	185.00	4.00	6-1565	205.00	5.00	6-846	234.20	7.00
6-1028	185.00	5.00	6-1153	206.00	7.00	6-618	234.32	1.78
6-1121	185.00	6.00	2-370	208.92	5.33	2-374	234.34	5.33
6-122	186.44	6.99	2-267	209.14	3.53	2-271	234.54	3.53
6-1007	187.10	8.40	6-600	209.20	5.70	2-176	234.62	2.62
6-466	188.00	4.00	2-172	209.22	2.62	6-1451	235.00	4.00
6-706	189.20	5.70	6-1118	210.00	4.00	6-1360	236.00	6.00
2-367	189.87	5.33	6-152	210.00	5.00	6-635	236.00	7.00
2-443	189.87	6.99	5-445	210.24	6.99	6-864	238.00	4.00
6-495	190.00	3.00	6-461	213.68	7.14	6-412	238.00	5.00

O-Ring sizes

Parker No.	Inside diameter mm	Cross section mm	Parker No.	Inside diameter mm	Cross section mm	Parker No.	Inside diameter mm	Cross section mm
6-1426	238.00	6.00	6-1042	261.00	6.00	6-1359	304.80	3.18
6-1282	238.00	10.00	6-336	262.00	5.33	6-935	307.57	3.53
6-1239	238.00	14.00	5-976	264.79	6.60	6-1351	309.30	5.70
6-604	240.00	3.00	6-1403	265.00	5.00	6-1371	310.00	5.00
6-1346	240.00	5.00	6-1190	266.00	4.00	6-1125	311.00	10.00
6-1284	240.00	8.00	2-378	266.07	5.33	6-607	315.00	4.00
6-1564	240.00	8.00	2-450	266.07	6.99	6-1171	315.00	5.00
6-436	240.00	12.00	2-275	266.29	3.53	6-510	315.00	6.00
6-1384	240.66	7.40	6-505	270.00	3.00	5-488	316.56	2.62
2-375	240.67	5.33	6-988	270.00	5.33	2-454	316.87	6.99
2-448	240.67	6.99	6-936	272.64	3.53	6-1210	320.00	3.00
2-272	240.89	3.53	6-175	273.05	3.53	6-716	320.00	6.00
2-177	240.97	2.62	6-1279	273.60	5.00	6-1458	320.00	6.50
6-281	241.00	7.00	6-948	274.00	5.33	6-153	320.50	5.33
6-407	242.00	6.00	6-1476	275.00	5.00	6-1172	320.62	3.53
6-878	245.00	3.00	2-379	278.77	5.33	6-1404	325.00	5.00
6-1155	245.00	5.00	2-451	278.77	6.99	6-947	325.00	5.33
6-1534	245.00	7.00	6-1667	278.99	2.62	6-1546	328.00	6.99
6-671	245.00	10.00	2-276	278.99	3.53	6-1126	329.00	10.00
6-967	245.00	10.85	6-638	281.00	5.00	2-382	329.57	5.33
6-1668	246.00	3.00	6-840	282.37	3.53	2-455	329.57	6.99
6-1263	246.00	4.00	6-234	283.00	12.00	2-279	329.79	3.53
2-376	247.02	5.33	6-1477	285.00	5.00	6-1258	330.00	5.00
2-273	247.24	3.53	6-238	285.00	12.00	6-283	330.00	6.00
2-178	247.32	2.62	6-1240	285.00	14.10	6-469	330.00	8.00
6-1030	248.00	5.00	6-1018	289.42	5.87	6-1408	331.50	6.00
6-1167	248.00	7.00	6-1191	290.00	5.00	6-517	335.00	3.00
6-1010	249.30	5.70	6-241	291.00	6.00	6-1129	335.00	7.00
6-514	250.00	3.00	2-380	291.47	5.33	6-1235	336.00	5.33
6-1132	250.00	8.00	2-452	291.47	6.99	6-1090	336.00	7.00
6-1582	250.00	10.00	2-277	291.69	3.53	6-1043	338.00	6.00
6-1227	252.00	4.00	6-1663	294.00	3.00	6-1218	340.00	4.00
2-377	253.37	5.33	6-917	296.00	6.00	6-1334	340.00	10.00
2-449	253.37	6.99	6-1424	297.00	4.00	6-813	341.00	14.00
2-274	253.59	3.53	6-854	298.00	2.62	2-456	342.27	6.99
6-842	255.00	4.00	6-1278	299.50	5.00	6-1255	343.00	6.00
6-1522	255.00	5.00	6-1168	300.00	6.00	6-1135	345.00	5.00
6-1388	256.00	4.00	6-1370	300.00	8.00	6-1583	350.00	10.00
6-896	257.20	14.00	6-1310	300.00	10.00	6-1639	351.21	4.00
6-718	258.40	1.60	2-381	304.17	5.33	6-1392	354.96	6.09
6-1231	260.00	4.00	2-453	304.17	6.99	2-383	354.97	5.33
6-871	260.00	5.00	2-278	304.39	3.53	2-457	354.97	6.99
6-1201	260.00	8.00	6-553	304.80	1.78	6-518	355.00	3.00

O-Ring sizes

Parker No.	Inside diameter mm	Cross section mm	Parker No.	Inside diameter mm	Cross section mm	Parker No.	Inside diameter mm	Cross section mm
2-280	355.19	3.53	6-741	428.00	5.70	6-260	506.00	2.62
6-895	359.20	13.80	6-898	429.00	6.00	2-389	506.81	5.33
6-1142	360.00	4.00	6-734	430.00	12.00	2-469	506.86	6.99
6-1101	360.00	7.50	6-1584	430.00	16.00	6-202	514.00	8.00
6-1205	362.00	5.00	2-283	430.66	3.53	6-394	514.00	8.00
6-672	364.00	10.00	2-386	430.66	5.33	6-1170	515.00	5.00
6-203	367.00	3.50	2-463	430.66	6.99	6-775	515.00	10.00
2-458	367.67	6.99	6-331	431.80	7.10	6-919	515.90	6.00
6-1254	368.00	6.00	6-939	434.00	6.99	6-1158	520.00	5.00
6-807	370.00	5.50	6-158	437.00	3.00	6-529	524.00	10.00
6-598	375.00	5.34	6-1256	440.00	4.00	6-951	526.00	6.99
6-682	375.00	10.00	6-1435	440.00	4.30	6-467	528.00	8.00
6-723	380.00	4.00	2-464	443.36	6.99	2-390	532.21	5.33
6-897	380.00	6.00	6-578	445.00	8.00	2-470	532.26	6.99
6-927	380.00	8.00	6-909	449.00	12.00	6-179	533.40	3.18
2-384	380.37	5.33	6-835	449.50	6.99	6-1409	534.00	8.00
2-459	380.37	6.99	6-1521	450.00	2.62	6-621	535.46	7.24
2-281	380.59	3.53	6-669	450.00	10.00	6-1608	538.00	6.00
6-204	381.00	5.00	6-530	455.00	8.00	6-1299	540.00	5.00
6-1328	383.60	5.00	2-284	456.06	3.53	6-836	543.50	6.99
6-1241	385.00	14.20	2-387	456.06	5.33	6-690	546.00	7.00
6-711	388.00	5.00	2-465	456.06	6.99	6-1641	546.00	2.62
6-1387	390.00	4.00	6-1128	460.00	5.34	6-670	550.00	10.00
2-460	393.07	6.99	6-1008	463.00	7.00	2-391	557.61	5.33
6-1374	395.00	12.00	6-1072	465.00	5.00	2-471	557.66	6.99
6-209	398.00	8.00	6-799	468.00	6.00	6-462	558.00	10.00
6-892	400.00	5.00	2-466	468.76	6.99	6-1229	564.30	6.99
6-458	400.00	12.00	6-827	470.00	10.00	6-709	565.00	7.00
6-934	401.71	3.53	6-930	477.00	10.50	6-176	577.85	6.99
2-282	405.26	3.53	6-1219	480.00	4.00	6-1300	579.00	5.00
2-385	405.26	5.33	6-1243	480.00	14.00	6-626	580.00	8.00
2-461	405.26	6.99	6-256	480.06	10.00	6-1127	580.50	3.53
6-938	409.00	6.99	2-388	481.41	5.33	2-392	582.68	5.33
6-1326	410.00	6.00	2-467	481.46	6.99	2-472	582.68	6.99
6-1335	412.00	8.00	6-834	484.86	3.53	6-1244	585.00	14.00
6-1242	415.00	14.20	6-1080	485.00	5.00	6-817	590.00	10.00
2-462	417.96	6.99	6-1444	490.00	5.00	6-831	590.00	3.50
6-1352	419.30	5.70	2-468	494.16	6.99	6-380	594.51	7.14
6-165	420.00	3.50	6-328	500.00	3.53	6-233	602.00	8.00
6-164	420.00	5.00	6-1221	500.00	5.00	6-1301	602.00	5.00
6-173	422.00	2.00	6-1420	500.00	6.00	6-422	607.00	4.00
6-215	425.00	6.00	6-800	500.00	8.00	6-320	608.00	10.00
5-525	425.83	3.18	6-261	504.00	6.99	2-393	608.08	5.33

O-Ring sizes

Parker No.	Inside diameter mm	Cross section mm	Parker No.	Inside diameter mm	Cross section mm	Parker No.	Inside diameter mm	Cross section mm
2-473	608.08	6.99	6-521	716.00	8.00	6-707	865.00	8.40
6-1220	610.00	4.00	6-372	720.00	6.99	6-890	870.00	8.00
6-1017	613.92	6.99	6-389	723.90	6.99	6-597	875.00	8.00
6-742	614.00	7.00	6-267	734.00	6.99	6-230	882.00	10.00
6-1157	615.00	5.00	6-1245	735.00	15.00	6-304	887.00	6.99
6-647	617.00	7.00	6-305	736.00	3.53	6-1156	890.00	5.00
6-265	619.50	8.00	6-1577	736.60	5.00	6-924	900.00	10.00
6-1528	621.00	8.50	6-228	740.00	10.00	6-249	910.00	6.99
6-278	622.00	8.00	6-1309	740.00	6.00	6-335	914.00	5.33
6-247	624.00	6.99	6-943	748.50	7.00	6-708	929.00	6.00
6-1262	632.00	6.00	6-1079	750.00	5.00	6-250	936.00	6.99
2-394	633.48	5.33	6-1071	755.00	5.00	6-409	940.00	10.00
2-474	633.48	6.99	6-417	760.00	5.00	6-269	950.50	10.06
6-536	635.00	5.00	6-303	763.01	6.99	6-302	955.00	12.60
6-986	635.00	9.00	6-1173	764.00	6.99	6-334	960.00	5.33
6-235	637.00	10.00	6-667	770.00	10.00	6-527	974.00	7.00
6-644	638.89	5.44	6-1222	770.00	7.00	6-232	984.00	10.00
6-1308	640.00	6.00	6-1215	780.00	7.00	6-460	996.00	7.00
6-381	647.70	6.99	6-248	783.00	6.99	6-534	1004.00	8.00
2-395	658.88	5.33	6-237	786.00	10.00	6-1213	1005.00	15.00
2-475	658.88	6.99	6-649	798.00	7.00	6-332	1011.00	5.33
6-1418	661.00	14.00	6-415	800.00	5.33	6-280	1016.00	7.00
6-653	664.00	5.00	6-279	810.00	7.10	6-239	1029.00	10.00
6-645	665.00	5.00	6-322	810.00	10.00	6-333	1042.00	5.33
6-816	670.00	10.00	6-509	819.00	7.00	6-270	1046.00	7.00
6-1443	675.00	5.30	6-648	820.00	7.00	6-393	1060.00	10.00
6-301	677.00	7.00	6-268	827.00	7.00	6-385	1071.00	14.40
6-535	680.00	5.00	6-1131	835.50	7.00	6-240	1075.00	10.00
6-236	689.00	10.00	6-229	837.00	10.00	6-271	1103.00	10.00
6-266	693.50	10.10	6-190	840.00	12.00	6-245	1154.00	10.00
6-701	695.00	6.99	6-1130	840.50	7.00	6-1304	1840.00	5.00
6-1160	695.00	5.00	6-508	849.00	7.00	6-1325	1865.00	5.00
6-321	700.00	10.00	6-330	850.00	10.00	6-1066	1960.00	10.85
5-092	701.68	6.99	6-650	853.00	7.00	6-1067	2072.00	10.00
6-702	707.00	6.99	6-1246	853.00	20.00	6-984	2965.00	7.00
6-668	708.00	10.00	6-1223	860.00	3.00			
6-531	710.00	5.33	6-363	865.00	12.00			

Parker Series 8-XXX Parbak® Back-up Ring Sizes



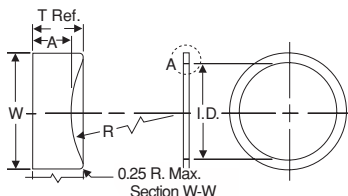

Developed primarily for service in petroleum based hydraulic fluids at -40°C to 121°C, Parker's standard Parbak N0300-90 and N1444-90 compounds provide the maximum benefits in back-up ring service. Compounds for use in other fluids and for temperatures up to 204°C are available on request. Parbaks will stretch up to 50%, and are quickly and easily installed. Advantages of the contour design are obtained regardless of how Parbaks are installed — they may be installed with the concave face in either direction, toward or away from the O-ring.



8-XXX Sizes

W 1.35 mm		W 1.35 mm		W 2.18 mm		W 2.18 mm		W 2.18 mm	
Parker No.	M mm	Parker No.	M mm	Parker No.	M mm	Parker No.	M mm	Parker No.	M mm
8-004	2.44	8-030	41.73	8-102	1.96	8-128	38.56	8-154	95.71
8-005	3.23	8-031	44.91	8-103	2.77	8-129	40.16	8-155	102.06
8-006	3.56	8-032	48.08	8-104	3.56	8-130	41.73	8-156	108.41
8-007	4.34	8-033	51.26	8-105	4.34	8-131	43.33	8-157	114.76
8-008	5.13	8-034	54.43	8-106	5.13	8-132	44.91	8-158	121.11
8-009	5.94	8-035	57.61	8-107	5.94	8-133	46.51	8-159	127.46
8-010	6.73	8-036	60.78	8-108	6.73	8-134	48.08	8-160	133.81
8-011	8.31	8-037	63.96	8-109	8.31	8-135	49.68	8-161	140.16
8-012	9.91	8-038	67.13	8-110	9.91	8-136	51.26	8-162	146.51
8-013	11.56	8-039	70.31	8-111	11.48	8-137	52.86	8-163	152.86
8-014	13.16	8-040	73.48	8-112	13.08	8-138	54.43	8-164	159.21
8-015	14.73	8-041	76.66	8-113	14.66	8-139	56.03	8-165	165.56
8-016	16.33	8-042	83.01	8-114	16.26	8-140	57.61	8-166	171.91
8-017	17.91	8-043	89.36	8-115	17.83	8-141	59.21	8-167	178.26
8-018	19.51	8-044	95.71	8-116	19.43	8-142	60.78	8-168	184.61
8-019	21.08	8-045	102.06	8-117	21.11	8-143	62.38	8-169	190.96
8-020	22.68	8-046	108.41	8-118	22.68	8-144	63.96	8-170	197.31
8-021	24.26	8-047	114.76	8-119	24.28	8-145	65.56	8-171	203.66
8-022	25.86	8-048	121.11	8-120	25.86	8-146	67.13	8-172	210.01
8-023	27.43	8-049	127.46	8-121	27.46	8-147	68.73	8-173	216.36
8-024	29.03	8-050	133.81	8-122	29.03	8-148	70.31	8-174	222.71
8-025	30.61			8-123	30.63	8-149	71.91	8-175	229.06
8-026	32.21			8-124	32.21	8-150	73.48	8-176	235.41
8-027	33.78			8-125	33.81	8-151	76.66	8-177	241.76
8-028	35.38			8-126	35.38	8-152	83.01	8-178	248.11
8-029	38.56			8-127	36.98	8-153	89.36		

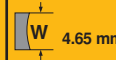
8-XXX Sizes

 3.00 mm		 3.00 mm		 4.65 mm		 4.65 mm		 4.65 mm	
Parker No.	M mm	Parker No.	M mm	Parker No.	M mm	Parker No.	M mm	Parker No.	M mm
8-201	5.13	8-243	104.93	8-309	11.43	8-351	121.36	8-393	609.42
8-202	6.73	8-244	108.10	8-310	13.03	8-352	124.54	8-394	634.82
8-203	8.30	8-245	111.28	8-311	14.60	8-353	127.71	8-395	660.22
8-204	9.90	8-246	114.45	8-312	16.20	8-354	130.89		
8-205	11.56	8-247	117.63	8-313	17.78	8-355	134.09		
8-206	13.16	8-248	121.11	8-314	19.38	8-356	137.24		
8-207	14.73	8-249	124.28	8-315	20.96	8-357	140.41		
8-208	16.33	8-250	127.46	8-316	22.56	8-358	143.59		
8-209	17.90	8-251	130.63	8-317	24.13	8-359	146.76		
8-210	19.46	8-252	133.81	8-318	25.73	8-360	149.94		
8-211	21.03	8-253	136.98	8-319	27.31	8-361	153.11		
8-212	22.63	8-254	140.16	8-320	28.91	8-362	159.46		
8-213	24.21	8-255	143.33	8-321	30.42	8-363	165.81		
8-214	25.81	8-256	146.51	8-322	32.08	8-364	172.16		
8-215	27.38	8-257	149.68	8-323	33.43	8-365	178.51		
8-216	28.98	8-258	152.86	8-324	35.26	8-366	184.86		
8-217	30.56	8-259	159.21	8-325	38.43	8-367	191.21		
8-218	32.16	8-260	165.56	8-326	41.61	8-368	197.56		
8-219	33.88	8-261	171.91	8-327	44.78	8-369	203.91		
8-220	35.48	8-262	178.26	8-328	47.96	8-370	210.26		
8-221	37.06	8-263	184.61	8-329	51.13	8-371	216.61		
8-222	38.66	8-264	190.96	8-330	54.31	8-372	222.96		
8-223	41.83	8-265	197.31	8-331	57.61	8-373	229.31		
8-224	45.01	8-266	203.66	8-332	60.78	8-374	235.66		
8-225	48.18	8-267	210.01	8-333	63.96	8-375	242.01		
8-226	51.36	8-268	216.36	8-334	67.13	8-376	248.36		
8-227	54.53	8-269	222.71	8-335	70.31	8-377	254.71		
8-228	57.71	8-270	229.06	8-336	73.48	8-378	267.41		
8-229	60.88	8-271	235.41	8-337	76.66	8-379	280.11		
8-230	64.06	8-272	241.76	8-338	79.83	8-380	292.81		
8-231	66.83	8-273	248.11	8-339	83.13	8-381	305.51		
8-232	70.00	8-274	254.46	8-340	86.31	8-382	330.91		
8-233	73.18	8-275	267.16	8-341	89.48	8-383	356.31		
8-234	76.35	8-276	279.86	8-342	92.66	8-384	381.71		
8-235	79.53	8-277	292.56	8-343	95.83	8-385	406.60		
8-236	82.70	8-278	305.26	8-344	99.01	8-386	432.00		
8-237	85.88	8-279	330.66	8-345	102.31	8-387	457.40		
8-238	89.05	8-280	356.05	8-346	105.49	8-388	482.75		
8-239	92.23	8-281	381.46	8-347	108.66	8-389	508.15		
8-240	95.40	8-282	406.12	8-348	111.84	8-390	533.55		
8-241	98.58	8-283	431.52	8-349	115.01	8-391	558.95		
8-242	101.75	8-284	456.92	8-350	118.19	8-392	584.02		

8-XXX Sizes

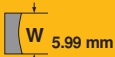
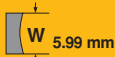
				Sonstige Abmessungen		Maßtoleranzen			
Parker No.	M mm	Parker No.	M mm	Parker No.	M mm	Parker No.	M mm	Parker No.	M mm
8-425	115.60	8-454	318.11	004-050	2.21	004-009	0.15 mm	004-284	0.08
8-426	118.77	8-455	330.81	102-178	3.28	009-012	0.18 mm	309-325	0.10
8-427	121.95	8-456	343.51	201-284	4.42	012-019	0.23 mm	425-475	0.13
8-428	125.20	8-457	356.21	309-395	6.65	020-029	1.00%		
8-429	128.30	8-458	368.91	425-475	8.74	030-041	0.86%		
8-430	131.47	8-459	381.61			042-050	0.78%		
8-431	134.65	8-460	394.31			102-107	0.15 mm		
8-432	137.82	8-461	406.50	Parker No.	T mm	108-110	0.18 mm	W mm	± mm
8-433	141.00	8-462	419.20			111-117	0.25 mm		
8-434	144.17	8-463	431.90			118-128	1.10 %		
8-435	147.35	8-464	444.60			004-050	1.24		
8-436	150.52	8-465	457.30	102-178	1.35	152-164	0.78%	2.18	0.08
8-437	153.70	8-466	470.00	201-284	1.27	165-178	0.74%	3.00	0.10
8-438	159.36	8-467	482.70	309-395	1.93	201-204	0.18 mm	4.65	0.13
8-439	165.71	8-468	495.40	425-475	2.97	204-211	0.25 mm	5.99	0.15
8-440	172.06	8-469	508.10			212-227	1.10%		
8-441	178.41	8-470	533.50			228-235	0.90%		
8-442	184.76	8-471	558.90	Parker No.	A mm	236-259	0.78%		
8-443	191.11	8-472	584.30			260-277	0.74%		
8-444	197.46	8-473	609.70			278-284	0.67%		
8-445	203.81	8-474	635.10			309-315	0.25 mm		
8-446	216.51	8-475	660.50	102-178	1.14	316-325	1.10%		
8-447	229.21			201-284	1.02	326-338	0.95%		
8-448	241.91			309-395	1.52	339-362	0.78%		
8-449	254.61			425-475	2.44	363-380	0.74%		
8-450	267.31					381-395	0.67%		
8-451	280.01					425-438	0.78%		
8-452	292.71					439-452	0.74%		
8-453	305.41					453-475	0.67%		

Please note:

1. On ordering both size and compound should be stated e.g. 8-130, N300-90.
2. Parbak size numbers correspond to O-rings in the 2-xxx series e.g. 8-211, N 300-90 is fitted with the O-ring 2-211, N 674-70).

General Notes

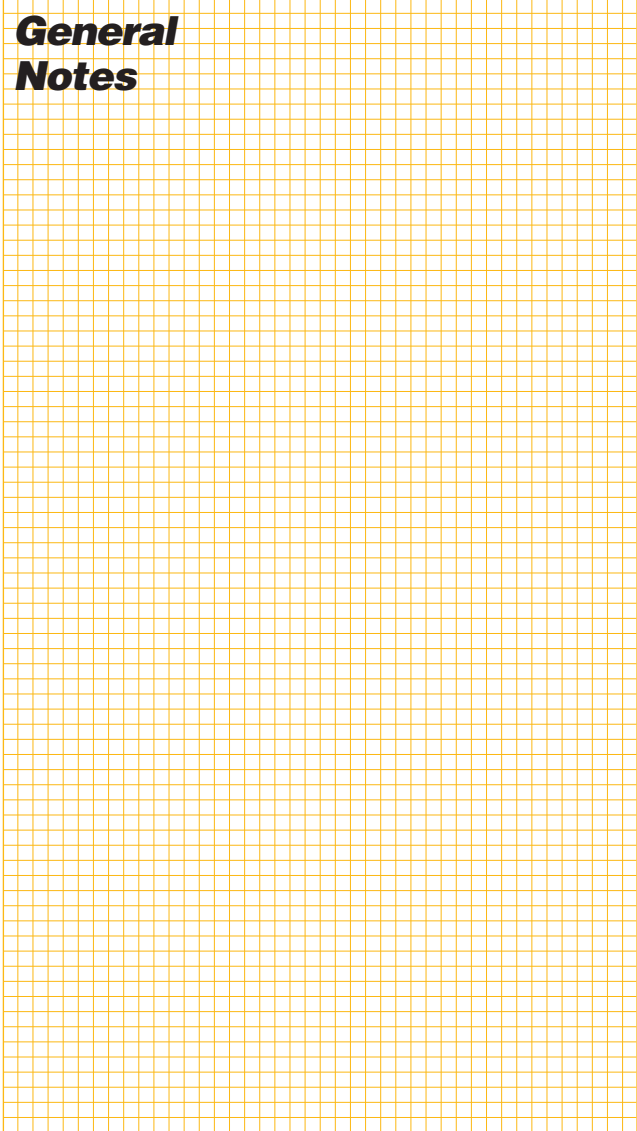

General Notes

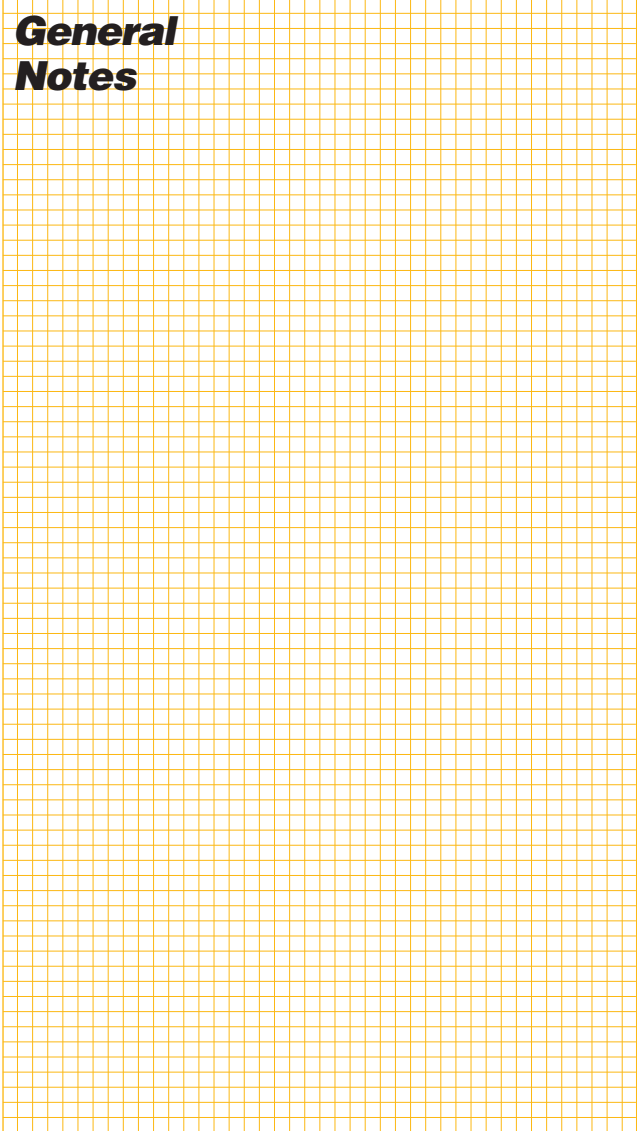

Serving Industry Worldwide

Around the corner or around the globe, Parker's O-Ring Division is there to provide engineered solutions to tough sealing problems.

The Parker Hannifin Corporation Seal Group is a worldwide leader in the development, manufacture and seals, vibration control, systems for shielding against electromagnetic interference as well as thermal management materials. The Group manufactures in more than 43 facilities, eight of which are in Europe.

This network - and the global sales and engineering support it provides - means that customers can always get quality products when and where they need them. It also means that sound advice from Parker sealing experts is never far away.



Pleidelsheim (D)
O-Ring Division
- O-rings, back-up rings
- Precision moulded parts



Bietigheim-Bissingen (D)
Packing Division
- Sealing systems for fluid power applications
- Special profiles



Marlow (UK)
Chomerics Division
- EMI shielding materials
- Thermal management materials



Adro (I)
O-Ring Division
- O-rings
- Precision moulded parts



Espergaerde (DK)
Packing Division
- PTFE Seals and precision moulded parts



Sadska (CZ)
Packing Division
O-Ring Division



Seal Group Europe O-Ring Division

For the latest information on Parker's O-Ring Division products,
visit www.parker.com/euro_oring

Your Authorized Parker Seal O-Ring Distributor:

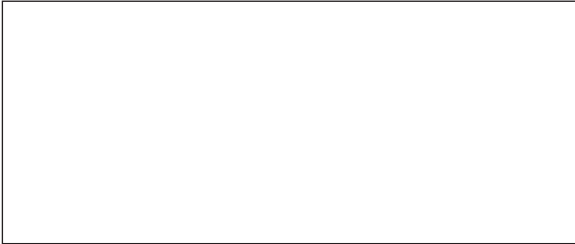

Hifluor[®], inPHorm[®], Parofluor[®], Parofluor Quantum[®], Parofluor Micro[®] and Parofluor ULTRA[®] are trademarks of Parker Hannifin Corporation.



Parker Hannifin GmbH & Co. KG
O-Ring Division Europe
Postfach 40
D-74383 Pleidelsheim
Telefon (0 71 44) 2 06-0
Telefax (0 71 44) 2 37 49
E-Mail: oring-europe@parker.com